

h h Y n h h d



2020
contract





Siesta, established in 1987, offers to an international public satisfying the most varied needs, through products conceived in the name of functionality and design.

The continuous attention to the needs and tendencies of the market has led to a constant and balanced development throughout time, determining a first hand position for both productive capacity and also from a commercial point of view. This has been possible thanks to constant research on productive and technological aspects and also on the esthetics and on product promotion.

The freshness of the design of Siesta tables and chairs together with the competitive price satisfies different levels of needs. These characteristics give Siesta access to different market sectors, for example contract and domestic.

The collection includes chairs, bar stools and tables, all designed to be multifunctional and multi-purpose, user friendly and with an indisputable style. With their colour, sense of irony, play on senses and unique forms, Siesta products are immediately recognizable throughout the world, offering longlasting, practical enjoyment. Today Siesta exports 75% of its production to 80 countries around the globe through its comprehensive network of agents and dealers.

Siesta offers an extremely wide range of indoor and outdoor products, with innumerable colour variations, with plastic materials like polypropylene and fiberglass matched to wood or metal or latest trend like transparent polycarbonate or glossy PA6 nylon, with strong technical characteristics, that give the product inimitable qualities such as softness, opaqueness, flexibility and resistance to atmospheric agents.















A concentrate of quality that makes the Siesta product so unique and special.



CHECKLIST OF OBJECTS

CHAIRS & ARMCHAIRS



					
MILA 18	PIA 20	SUNSET 22	PLUS 24	SNOW 26	MOON 28
					
JOSEPHINE 42	NAPOLEON 44	OPERA 46	CHIAVARI 48	CRYSTAL 50	DEJAVU 52
					
MISS BIBI 66	MR BOBO 68	CARMEN 70	ALLEGRA 72	ALLEGRA-PP 74	MIO-PP 76
					
ARTEMIS 90	ARTEMIS XL 92	TIFFANY 94	TIFFANY-S 96	LUCCA 98	LUCCA-T 100
LOUNGE					
		MYKONOS LOUNGE SET XL 114		MYKONOS LOUNGE SET 118	

					
SKY 6	SKY LOUNGE 8	MONNA 10	LISA 12	LUCY 14	LOFT 16
					
FLASH 30	BLOOM 32	AIR XL 34	AIR 36	MIRANDA 38	SOHO 40
					
ELIZABETH 54	BABY ELIZABETH 56	ELIZABETH-C 58	ARTHUR 60	BO 62	BEE 64
					
MIO 78	MAYA 80	DIVA 82	BOX 84	BOX SOFA 86	ARES 88
					
DOLCE 102	VITA 104	ROMEO 106	JULIETTE 108	GALA 110	BELLA 112
					
MYKONOS LOUNGE CORNER SET 122		MYKONOS LOUNGE ARMCHAIR 126	MYKONOS LOUNGE TABLE 128	MYKONOS LOUNGE TABLE XL 130	MYKONOS EXTENSION PART 132

CHECKLIST OF OBJECTS			SUNLOUNGER ▶		
					PACIFIC 134
					
OPERA BAR 65 144	CHIAVARI BAR 75 146	CHIAVARI BAR 65 148	FOX 75 150	FOX 65 152	AIR BAR 75 154
			TABLES ▶		
BOX TABLE 168	OCEAN SIDE TABLE 170	OCEAN TABLE 172			VEGAS TABLE 174
					
AIR TABLE 140 188	AIR TABLE 180 190	SKY FOLDING LEGS 192	SKY LEGS 194	AIR LEGS SMALL 196	AIR LEGS MEDIUM 196
					
MAYA 80 208	MAYA 120 208	MAYA 140 208	ICE 214	ICE 214	ICE LEG&BASE 218
LIGHTING ▶					LINKING ▶
		DODO 232	NOVA 234	SMART 236	

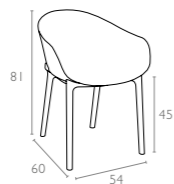
STOOLS & COMPLEMENTS ▶					
		MAYA BAR 75 136	MAYA BAR 65 138	ARES BAR 75 140	OPERA BAR 75 142
					
AIR BAR 65 156	ARIA 158	GIO 160	QUEEN 162	SKY SIDE TABLE 164	SKY LOUNGE TABLE 166
					
VEGAS TABLE MEDIUM 176	VEGAS TABLE XL 178	SKY FOLDING TABLE 60 180	SKY TABLE 70 182	SKY TABLE 80 184	AIR TABLE 80 186
					
AIR LEGS XL 196	OCTOPUS 60 198	OCTOPUS BAR 200	SKY FOLDING BAR TABLE 60 202	ARES 80 204	ARES 140 206
					
MANGO 220	MANGO ALU 222	FORZA 224	SORTIE 226	POPPY 80 228	ELFO 70 230
	CUSHIONS ▶				
LINK LINKING DEVICE 238			ARTEMIS XL CUSHIONS 240	MYKONOS CUSHIONS 242	



Sky armchair is produced with recyclable polypropylene seat and legs reinforced with glass fiber. For indoor and outdoor use. Can be disassembled.

102 Sky

CATAS Testato - Tested



Colors



White Black Dark Grey Taupe Red



Yellow



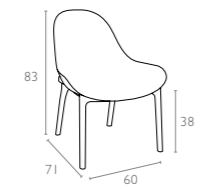
Sky Lounge



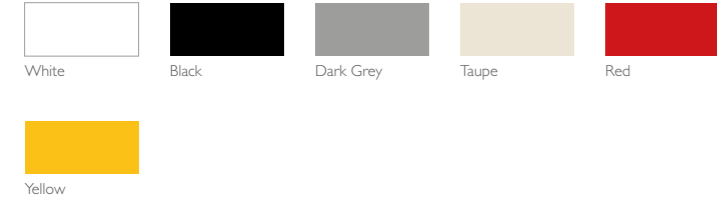
Sky lounge chair is produced with recyclable polypropylene seat and legs reinforced with glass fiber. For indoor and outdoor use. Can be disassembled. The SKY collection also includes a coffee table, designed to match the styling silhouette of the chair to perfection.

103 Sky Lounge

CATAS Testato - Tested



Colors



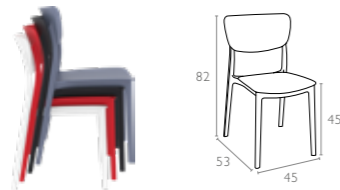
Monna



Monna chair is produced with a single injection of polypropylene reinforced with glass fiber obtained by means of the latest generation of air moulding technology with neutral tones. For indoor and outdoor use.

127 Monna

CATAS Testato - Tested



Colors



White Black Dark Grey Taupe Red



Olive Green

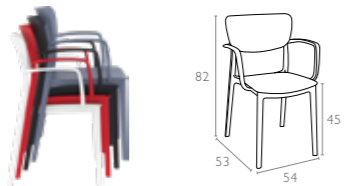




Lisa armchair is produced with a single injection of polypropylene reinforced with glass fiber obtained by means of the latest generation of air moulding technology with neutral tones. For indoor and outdoor use.

126 Lisa

CATAS Testato - Tested



Colors



White Black Dark Grey Taupe Red



Olive Green





Lucy chair is produced with a single injection of polypropylene reinforced with glass fiber obtained by means of the latest generation of air moulding technology with neutral tones. For indoor and outdoor use.

129 Lucy

CATAS Testato - Tested



Colors



White

Black

Dark Grey

Taupe

Olive Green

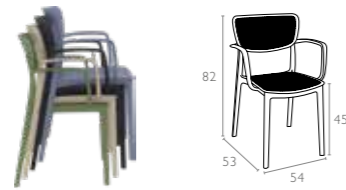




Loft armchair is produced with a single injection of polypropylene reinforced with glass fiber obtained by means of the latest generation of air moulding technology with neutral tones. For indoor and outdoor use.

128 Loft

CATAS Testato - Tested



Colors



White

Black

Dark Grey

Taupe

Olive Green





Mila armchair is produced with a single injection of polypropylene reinforced with glass fiber obtained by means of the latest generation of air moulding technology with neutral tones. For indoor and outdoor use.



085 Mila

CATAS Testato - Tested



Colors



White

Black

Dark Grey

Taupe

Red



Yellow





Pia chair is produced with a single injection of polypropylene reinforced with glass fiber obtained by means of the latest generation of air moulding technology with neutral tones. For indoor and outdoor use.



086 Pia

CATAS Testato - Tested



Colors



White

Black

Dark Grey

Taupe

Red



Yellow





Sunset chair is produced with a single injection of polypropylene reinforced with glass fiber obtained by means of the latest generation of air moulding technology with neutral tones. For indoor and outdoor use.



088 Sunset

CATAS Testato - Tested



Colors



White

Black

Dark Grey

Brown

Taupe

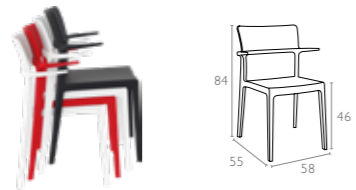




Plus armchair is produced with a single injection of polypropylene reinforced with glass fiber obtained by means of the latest generation of air moulding technology with neutral tones. For indoor and outdoor use.

093 Plus

CATAS Testato - Tested



Colors



White



Black



Red

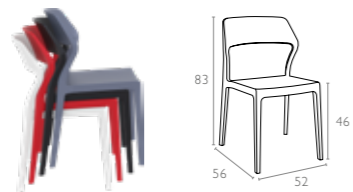




Snow chair is produced with a single injection of polypropylene reinforced with glass fiber obtained by means of the latest generation of air moulding technology with neutral tones. For indoor and outdoor use.

092 Snow

CATAS Testato - Tested



Colors



White

Black

Dark Grey

Taupe

Red



Yellow



Olive Green



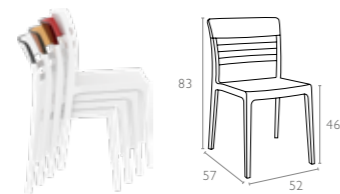


Stacking chair with the latest generation of air moulding thermoplastic injection. Seat in polypropylene reinforced with glass fiber, backrest in transparent polycarbonate. For indoor and outdoor use.

090 Moon

CATAS Testato - Tested

Made with
Makrolon®
The high-tech polycarbonate



Colors



White /
Glossy White

White /
Red Transparent

White /
Amber Transparent

White /
Clear Transparent

Black /
Clear Transparent



Black /
Black Transparent



Black /
Amber Transparent



Black /
Red Transparent



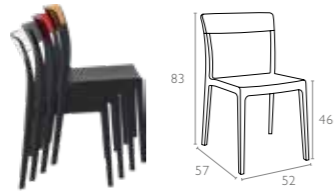


Stacking chair with the latest generation of air moulding thermoplastic injection. Seat in polypropylene reinforced with glass fiber, backrest in transparent polycarbonate. For indoor and outdoor use.

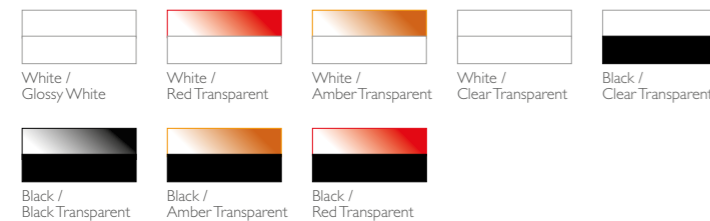
091 Flash

CATAS Testato - Tested

Made with
Makrolon®
The high-tech polycarbonate



Colors

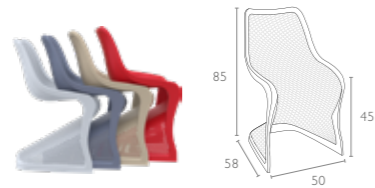




Bloom chair is produced with a single injection of polypropylene reinforced with glass fiber obtained by means of the latest generation of air moulding technology with neutral tones. For indoor and outdoor use.

048 Bloom

CATAS Testato - Tested



Colors



White

Black

Dark Grey

Silver Grey

Taupe



Red



Yellow

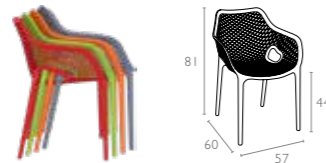




Air XL armchair is produced with a single injection of polypropylene reinforced with glass fiber obtained by means of the latest generation of air moulding technology with neutral tones. For indoor and outdoor use.

007 Air XL

CATAS Testato - Tested



Colors



White

Black

Dark Grey

Red

Taupe



Tropical Green



Orange



Yellow





Air chair is produced with a single injection of polypropylene reinforced with glass fiber obtained by means of the latest generation of air moulding technology with neutral tones. For indoor and outdoor use.

014 Air

CATAS Testato - Tested



Colors



White

Black

Dark Grey

Red

Taupe



Tropical Green



Orange



Yellow





Miranda chair is produced with a single injection of polypropylene reinforced with glass fiber obtained by means of the latest generation of air moulding technology with neutral tones. For indoor and outdoor use.

039 Miranda

CATAS Testato - Tested



Colors



White

Black

Dark Grey

Brown

Taupe





Soho chair is produced with a single injection of polypropylene reinforced with glass fiber obtained by means of the latest generation of air moulding technology with neutral tones. For indoor and outdoor use.

054 Soho

CATAS Testato - Tested



Colors



White

Black

Dark Grey

Brown

Taupe



Red

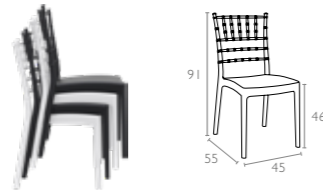




Josephine wedding chair is produced with a single injection of polypropylene reinforced with glass fiber obtained by means of the latest generation of air moulding technology with neutral tones. For indoor and outdoor use.

050 Josephine

CATAS Testato - Tested



Colors



White



Black



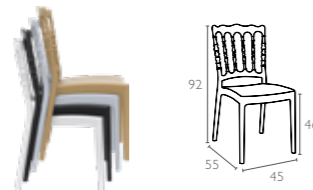
Napoleon



Napoleon wedding chair is produced with a single injection of polypropylene reinforced with glass fiber obtained by means of the latest generation of air moulding technology with neutral tones. For indoor and outdoor use.

044 Napoleon

CATAS Testato - Tested



Colors



White

Black

Silver Grey

Gold



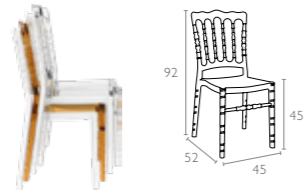


Stacking wedding chair for indoor and outdoor use in clear or shiny polycarbonate. Scratch resistant, UV - resistant.

061 Opera

CATAS Testato - Tested

Made with
Makrolon®
The high-tech polycarbonate



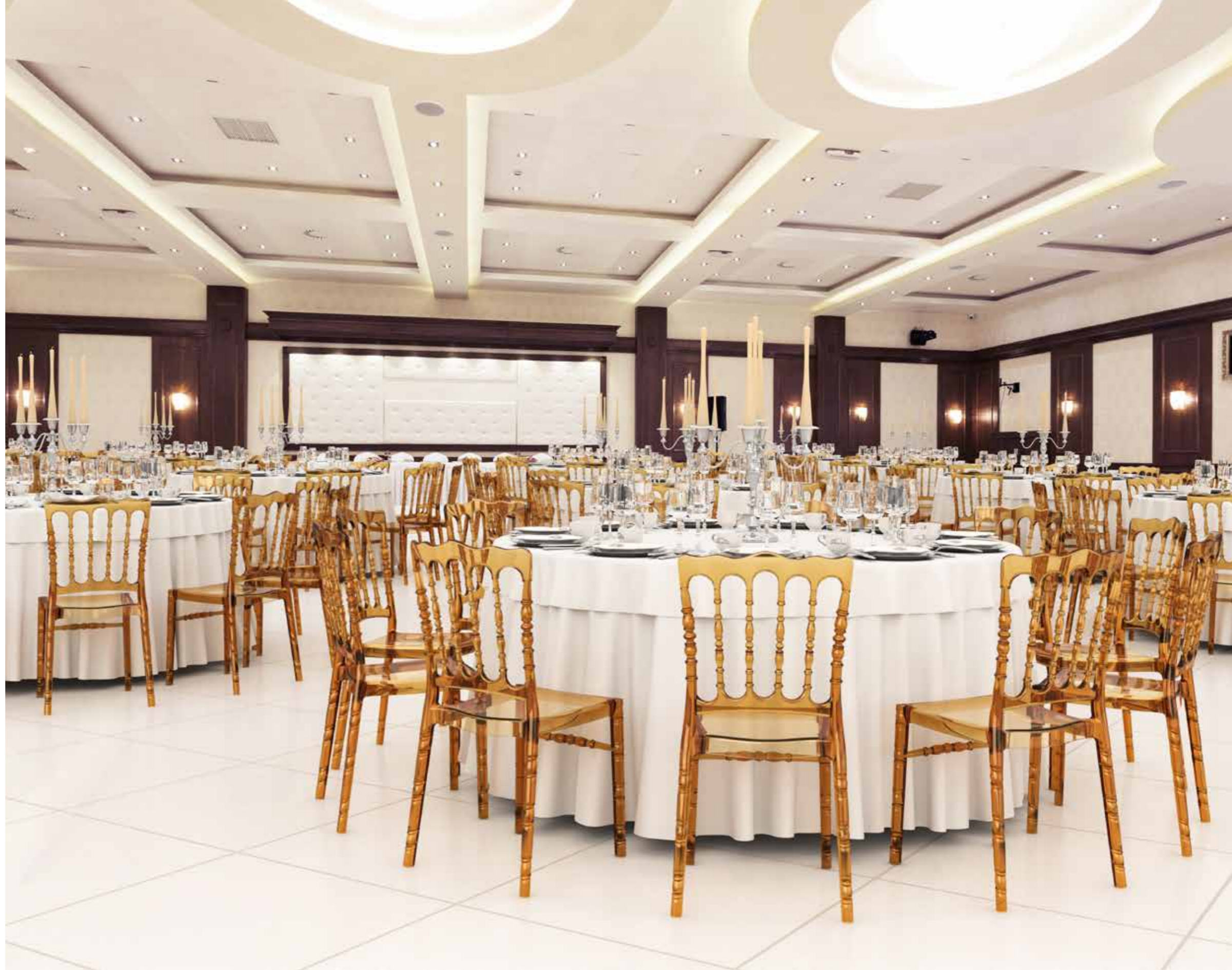
Colors



Glossy White

Amber Transparent

Clear Transparent



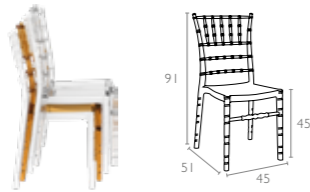


Stacking wedding chair for indoor and outdoor use in clear or shiny polycarbonate. Scratch resistant, UV - resistant.

071 Chiavari

CATAS Testato - Tested

Made with
Makrolon®
The high-tech polycarbonate



Colors



Glossy White

Amber Transparent

Clear Transparent



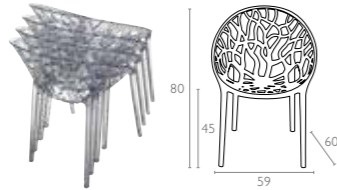


Stacking armchair for indoor and outdoor use in clear polycarbonate moulded with gas technology of the second generation. Scratch resistant, UV - resistant.

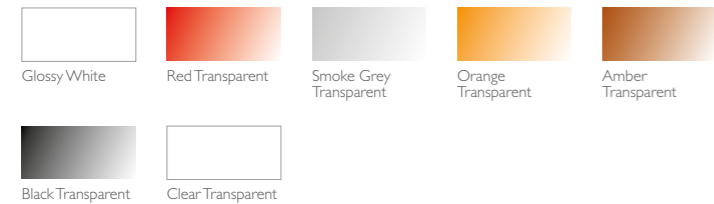
052 Crystal

CATAS Testato - Tested

Made with
Makrolon®
The high-tech polycarbonate



Colors



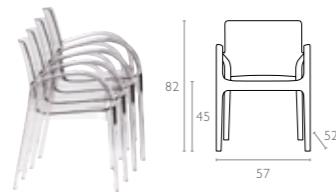


Stacking armchair for indoor and outdoor use in shiny technopolymer PA6 nylon or clear polycarbonate moulded with gas technology of the second generation. Scratch resistant, self - extinguish classification V2, UV - resistant.

032 Dejavu

CATAS Testato - Tested

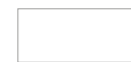
Made with
Makrolon®
The high-tech polycarbonate



Colors



Glossy White Glossy Red Smoke Grey Transparent Amber Transparent Black Transparent



Clear Transparent



Elizabeth

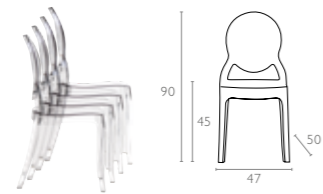


Stacking chair for indoor and outdoor use in shiny technopolymer PA6 nylon or clear polycarbonate. Scratch resistant, self - extinguish classification V2, UV - resistant.

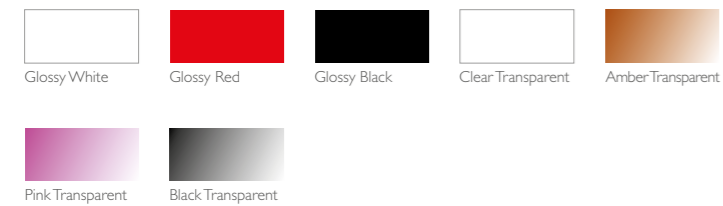
034 Elizabeth

CATAS Testato - Tested

Made with **Makrolon®**
The high-tech polycarbonate



Colors



Baby Elizabeth

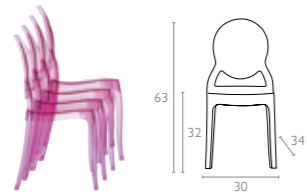


Stacking children chair Baby Elizabeth for indoor and outdoor use in clear polycarbonate. Scratch resistant, UV – resistant.

051 Baby Elizabeth

CATAS Testato - Tested

Made with
Makrolon®
The high-tech polycarbonate



Colors



Clear Transparent



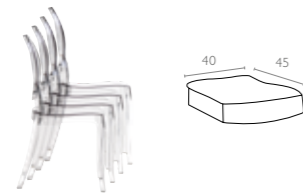


Stacking chair for indoor use with removable cushion on the seat, in shiny technopolymer PA6 nylon or clear polycarbonate.

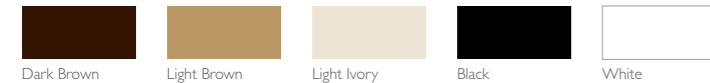
034 Elizabeth-C

CATAS Testato - Tested

Made with
Makrolon®
The high-tech polycarbonate



Cushion Colors



Dark Brown

Light Brown

Light Ivory

Black

White



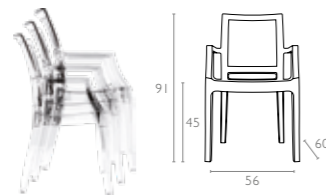


Stacking armchair for indoor and outdoor use in shiny technopolymer PA6 nylon or clear polycarbonate. Scratch resistant, self-extinguishing classification V2, UV-resistant.

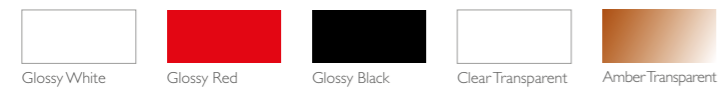
053 Arthur

CATAS Testato - Tested

Made with **Makrolon®**
The high-tech polycarbonate



Colors



Black Transparent



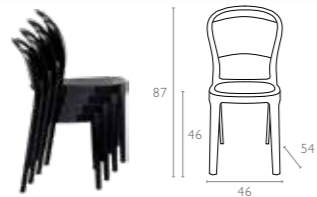


Stacking chair for indoor and outdoor use in clear or shiny polycarbonate. Scratch resistant, UV - resistant.

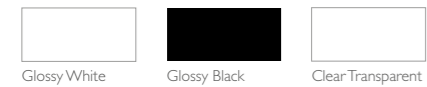
005 Bo

CATAS Testato - Tested

Made with
Makrolon®
The high-tech polycarbonate



Colors



Glossy White

Glossy Black

Clear Transparent






Stacking chair for indoor and outdoor use in clear or shiny polycarbonate. Scratch resistant, UV - resistant.

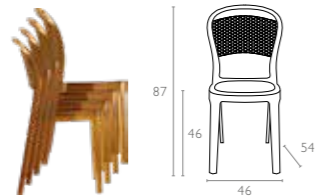
Design By

 ILANIT OVADYA

021 Bee

CATAS Testato - Tested

Made with
 **Makrolon®**
 The high-tech polycarbonate



Colors



Clear Transparent



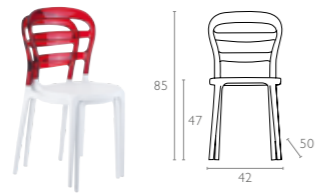


Stacking chair with the latest generation of air moulding thermoplastic injection. Seat in polypropylene reinforced with glass fiber, backrest in transparent polycarbonate. For indoor and outdoor use.

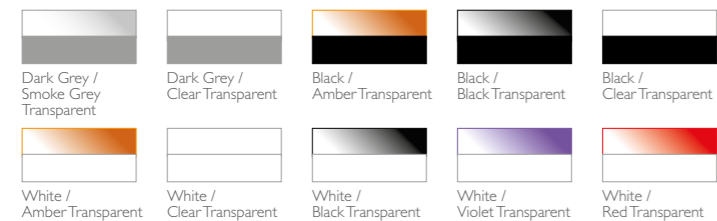
055 Miss Bibi

CATAS Testato - Tested

Made with
Makrolon[®]
The high-tech polycarbonate



Colors





Stacking chair with the latest generation of air moulding thermoplastic injection. Seat in polypropylene reinforced with glass fiber, backrest in transparent polycarbonate. For indoor and outdoor use.

056 Mr Bobo

CATAS Testato - Tested

Made with
Makrolon®
The high-tech polycarbonate



Colors



Dark Grey / Smoke Grey Transparent Dark Grey / Clear Transparent Black / Black Transparent Black / Clear Transparent White / Amber Transparent

White / Black Transparent White / Clear Transparent



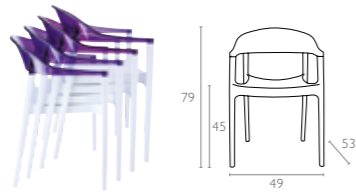


Stacking armchair with the latest generation of air moulding thermoplastic injection. Seat in polypropylene reinforced with glass fiber, backrest in transparent polycarbonate. For indoor and outdoor use.

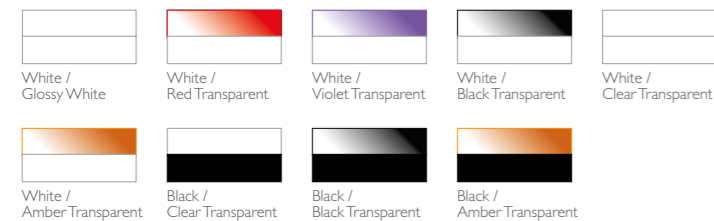
059 Carmen

CATAS Testato - Tested

Made with
Makrolon®
The high-tech polycarbonate



Colors

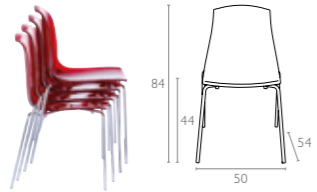




Recyclable polycarbonate main body. Legs frame in tubular chrome steel. Stackable. For indoor use.

057 Allegra

Made with
Makrolon®
The high-tech polycarbonate



Colors

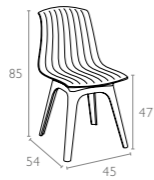


Allegra-PP



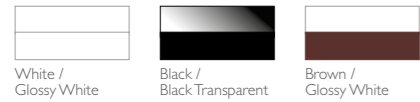
Recyclable polycarbonate main body. Legs frame in polypropylene.
For indoor and outdoor use. Can be disassembled.

096 Allegra-PP



Made with **Makrolon®**
The high-tech polycarbonate

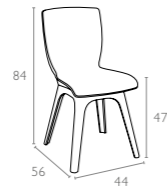
Colors





Mio-PP chair is produced with recyclable polypropylene seat and legs reinforced with glass fiber. For indoor and outdoor use. Can be disassembled.

094 Mio-PP



Colors



White / White

Black / Black

Brown / White





Stacking chair with recyclable polypropylene seat and backrest and painted steel legs. For indoor use.

046 Mio



Colors



Black

Orange

Red

Beige

White

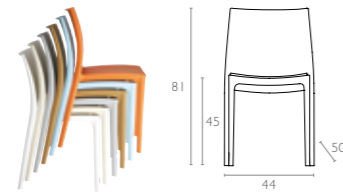




The latest generation air moulding process, as used for Maya, allows perfect control for the channel draining and the wall thickness. In designing Maya, the designers developed a formally characterized shape yet suitable for different ambiances - contemporary, classic, informal or elegant - where it easily settles in, thanks to a colour range including brights as well as neutral tones. For indoor and outdoor use.

025 Maya

CATAS Testato - Tested



Colors

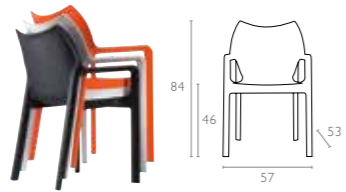




Diva armchair is produced with a single injection of polypropylene reinforced with glass fiber obtained by means of the latest generation of air moulding technology with neutral tones. For indoor and outdoor use.

028 Diva

CATAS Testato - Tested



Colors

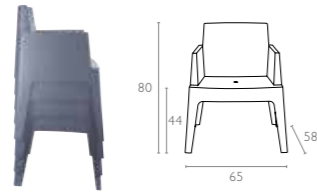




Recyclable polypropylene stacking armchair, strong and stable.
Suitable for outdoor contract use.

058 Box

CATAS Testato - Tested



Colors



Black

Red

Silver Grey

Dark Grey

Tropical Green



Orange



White



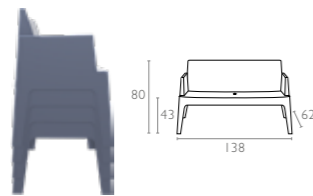
Box Sofa



Recyclable polypropylene stackable sofa, very sturdy and stable.
Suitable for outdoor contract use.

063 Box Sofa

CATAS Testato - Tested



Colors

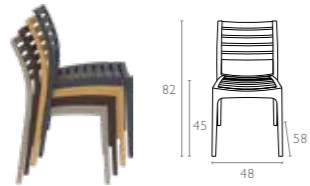




Ares chair is produced with a single injection of polypropylene reinforced with glass fiber obtained by means of the latest generation of air moulding technology with neutral tones. For indoor and outdoor use.

009 Ares

CATAS Testato - Tested



Colors



White Black Dark Grey Silver Grey Brown



Taupe Teak

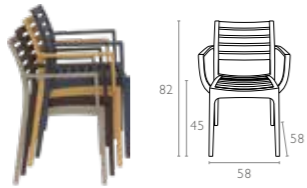




Artemis armchair is produced with a single injection of polypropylene reinforced with glass fiber obtained by means of the latest generation of air moulding technology with neutral tones. For indoor and outdoor use.

011 Artemis

CATAS Testato - Tested



Colors



White

Black

Dark Grey

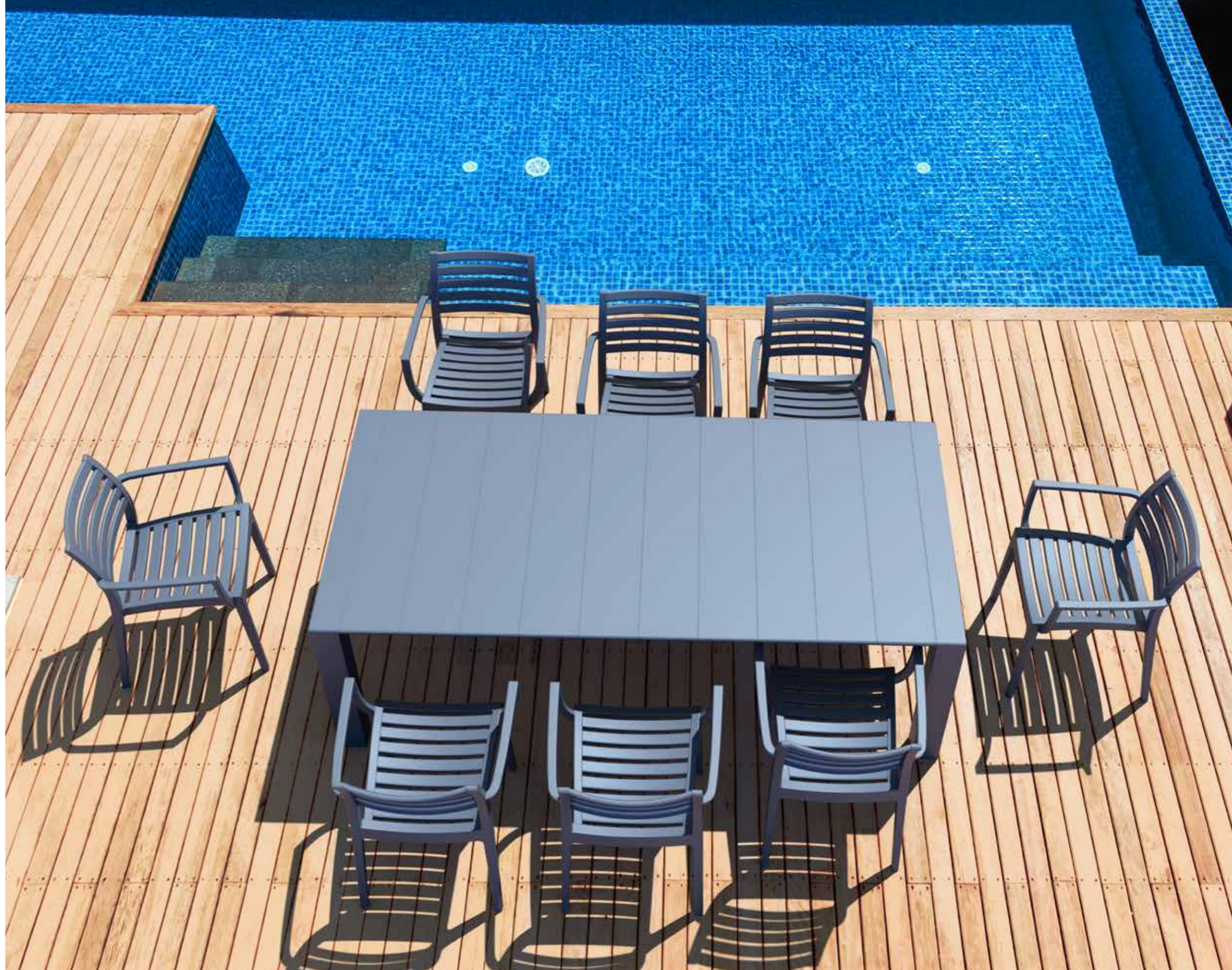
Silver Grey

Brown



Taupe

Teak



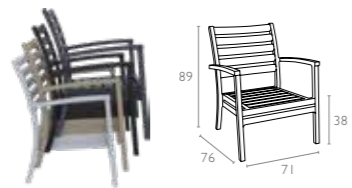
Artemis XL



Artemis XL Lounge armchair is stackable and produced with a single injection of polypropylene reinforced with glass fiber, for indoor and outdoor use with or without cushion and non-slip feet. The Artemis collection also includes a coffee table, in various sizes, designed to match the styling silhouette of the chair to perfection.

004 Artemis XL

CATAS Testato - Tested



Colors

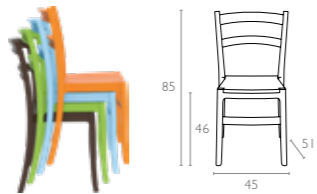




Tiffany chair is produced with a single injection of polypropylene reinforced with glass fiber obtained by means of the latest generation of air moulding technology with neutral tones. Stackable. For indoor and outdoor use.

018 Tiffany

CATAS Testato - Tested



Colors



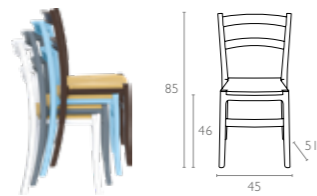
Tiffany-S



Tiffany-S chair is produced with a single injection of polypropylene reinforced with glass fiber obtained by means of the latest generation of air moulding technology with neutral tones. Stackable. For indoor and outdoor use.

019 Tiffany-S

CATAS Testato - Tested



Colors



Brown

Dark Grey

Light Blue

White

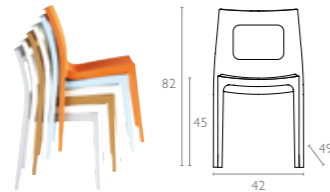




Stacking chair with the latest generation of air moulding thermoplastic injection. For indoor and outdoor use.

026 Lucca

CATAS Testato - Tested



Colors



White



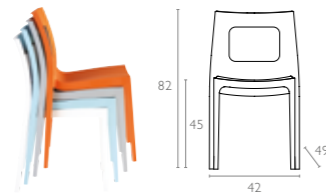


Stacking chair with the latest generation of air moulding thermoplastic injection. Back in transparent polycarbonate.
For indoor and outdoor use.

029 Lucca-T

CATAS Testato - Tested

Made with
Makrolon®
The high-tech polycarbonate



Colors



Light Blue

Orange

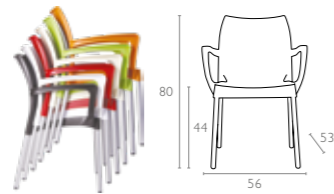
White





Stacking armchair with recyclable polypropylene seat and backrest and anodized aluminium legs. Diameter 25 mm. For indoor and outdoor use.

047 Dolce



Colors



Black

Light Green

Orange

Red

Beige



Dark Grey



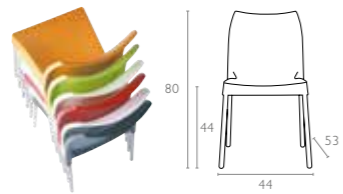
White





Stacking chair with recyclable polypropylene seat and backrest and anodized aluminium legs. Diameter 25 mm.
For indoor and outdoor use.

049 Vita



Colors



Black Light Green Orange Red Beige



Dark Grey White





Stacking armchair with recyclable polypropylene seat and backrest and anodized aluminium legs. Diameter 25 mm. For indoor and outdoor use.

043 Romeo



Colors



Blue

Black

Light Green

Orange

Red



Beige

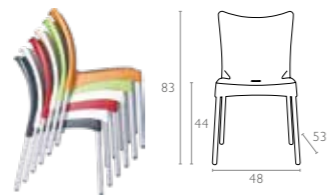
White





Stacking chair with recyclable polypropylene seat and backrest and anodized aluminium legs. Diameter 25 mm. For indoor and outdoor use.

045 Juliette



Colors



Blue

Black

Light Green

Orange

Red



Beige

White

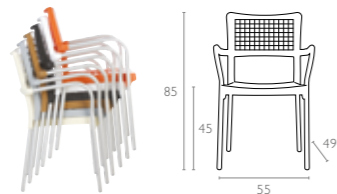




Stacking armchair in anodized aluminium with seat and back in recyclable polypropylene with latest generation of air moulding thermoplastic injection. Diameter 25 mm. For indoor and outdoor use.

041 Gala

CATAS Testato - Tested



Colors



Teak

Orange

White

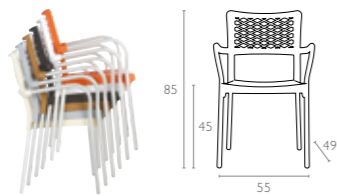




Stacking armchair in anodized aluminium with seat and back in recyclable polypropylene with latest generation of air moulding thermoplastic injection. Diameter 25 mm. For indoor and outdoor use.

040 Bella

CATAS Testato - Tested



Colors



Teak

Orange

White

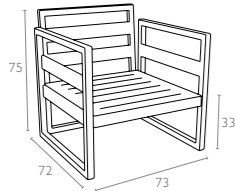


Mykonos Lounge Set XL

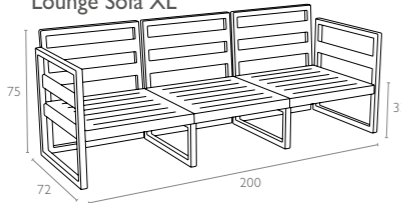


Mykonos Lounge Set XL is designed for easy self assembly, it is made of durable weather-resistant resin reinforced with glass fiber. Non-metallic frame will never unravel, rust or decay. It is UV protected which insures the colors will not fade. Can be disassembled. For indoor and outdoor contract use.

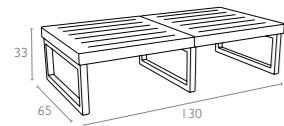
Mykonos
Lounge Armchair



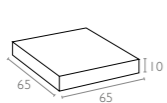
Mykonos
Lounge Sofa XL



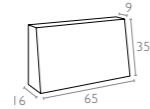
Mykonos
Lounge Table XL



Mykonos
Seat Cushion



Mykonos
Backrest Cushion



133 Mykonos Lounge Set XL

CATAS Testato - Tested

Colors



White Taupe Silver Grey

Cushions



Beige Light Brown Dark Grey Black

etisilk
Outdoor Furniture Fabrics



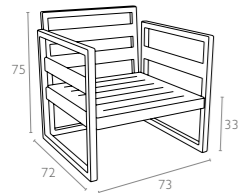


Mykonos Lounge Set

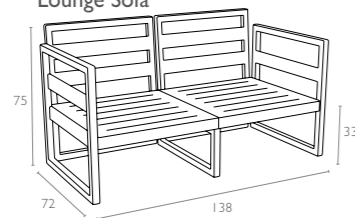


Mykonos Lounge Set is designed for easy self assembly, it is made of durable weather-resistant resin reinforced with glass fiber. Non-metallic frame will never unravel, rust or decay. It is UV protected which insures the colors will not fade. Can be disassembled. For indoor and outdoor contract use.

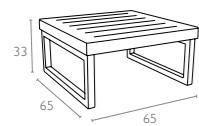
Mykonos
Lounge Armchair



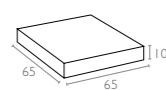
Mykonos
Lounge Sofa



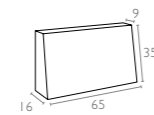
Mykonos
Lounge Table



Mykonos
Seat Cushion



Mykonos
Backrest Cushion



132 Mykonos Lounge Set

CATAS Testato - Tested

Colors



White

Taupe

Silver Grey

Cushions



Beige

Light Brown

Dark Grey

Black

etisilk
Outdoor Furniture Fabrics



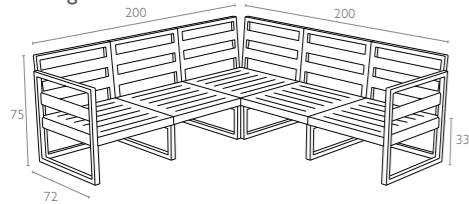


Mykonos Lounge Corner Set

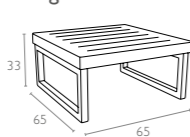


Mykonos Lounge Corner Set is designed for easy self assembly, it is made of durable weather-resistant resin reinforced with glass fiber. Non-metallic frame will never unravel, rust or decay. It is UV protected which insures the colors will not fade. Can be disassembled. For indoor and outdoor contract use.

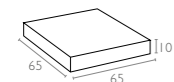
Mykonos Lounge Corner



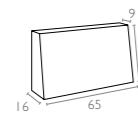
Mykonos Lounge Table



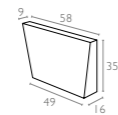
Mykonos Seat Cushion



Mykonos Backrest Cushion



Mykonos Corner Cushion



134 Mykonos Lounge Corner Set

CATAS Testato - Tested

Colors



White

Taupe

Silver Grey

Cushions



Beige

Light Brown

Dark Grey

Black

etisilk
Outdoor Furniture Fabrics





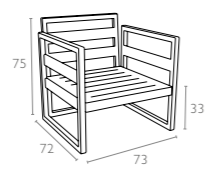
Mykonos Lounge Armchair



Mykonos Lounge Armchair is designed for easy self assembly, it is made of durable weather-resistant resin reinforced with glass fiber. Non-metallic frame will never unravel, rust or decay. It is UV protected which insures the colors will not fade. Can be disassembled. For indoor and outdoor contract use.

131 Mykonos Lounge Armchair

CATAS Testato - Tested



Colors



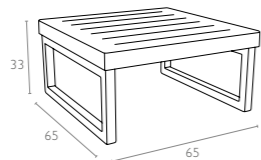
Mykonos Lounge Table



Mykonos Lounge Table is made of durable weather-resistant resin. Non-metallic frame will never unravel, rust or decay. It is UV protected which insures the colors will not fade. Can be disassembled. For indoor and outdoor use.

137 Mykonos Lounge Table

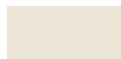
CATAS Testato - Tested



Colors



White



Taupe



Silver Grey



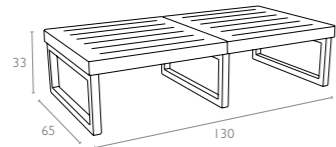
Mykonos Lounge Table XL



Mykonos Lounge Table XL is made of durable weather-resistant resin. Non-metallic frame will never unravel, rust or decay. It is UV protected which insures the colors will not fade. Can be disassembled. For indoor and outdoor use.

138 Mykonos Lounge Table XL

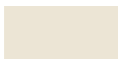
CATAS Testato - Tested



Colors



White



Taupe



Silver Grey



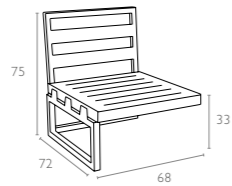
Mykonos Extension Part



With the extension part you can add as many seats as you want to extend your corner set.

136 Mykonos Extension Part

CATAS Testato - Tested



Colors



White

Taupe

Silver Grey



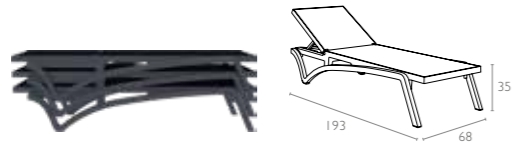


Sunlounger without arms, tubular frame in resin reinforced with glass fiber and cover in breathable synthetic fabric (replaceable). Stackable, back reclining in 5 positions, with non-slip feet and small wheels.

089 Pacific

CATAS Testato - Tested

Serge Ferrari



Colors



White / White

White / Taupe

White / Yellow

White / Turquoise

White / Blue



Dark Grey / Black

Black / Black



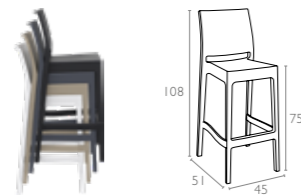
Maya Bar 75



Maya stacking bar stool h.75 cm is produced with a single injection of polypropylene reinforced with glass fiber obtained by means of the latest generation of air moulding technology with neutral tones. For indoor and outdoor use.

099 Maya Bar 75

CATAS Testato - Tested



Colors



White

Black

Dark Grey

Taupe

Olive Green



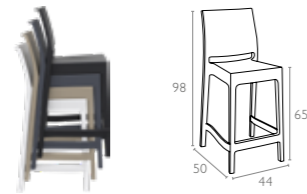
Maya Bar 65



Maya stacking bar stool h.65 cm is produced with a single injection of polypropylene reinforced with glass fiber obtained by means of the latest generation of air moulding technology with neutral tones. For indoor and outdoor use.

100 Maya Bar 65

CATAS Testato - Tested



Colors



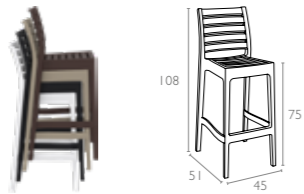
Ares Bar 75



Ares stacking bar stool h.75 cm is produced with a single injection of polypropylene reinforced with glass fiber obtained by means of the latest generation of air moulding technology with neutral tones. For indoor and outdoor use.

101 Ares Bar 75

CATAS Testato - Tested



Colors



White

Black

Dark Grey

Brown

Taupe



Opera Bar 75

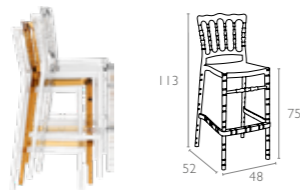


Stacking wedding bar stool h.75 cm for indoor and outdoor use in clear or shiny polycarbonate. Scratch resistant, UV - resistant.

073 Opera Bar 75

CATAS Testato - Tested

Made with
Makrolon®
The high-tech polycarbonate



Colors



Glossy White

Amber Transparent

Clear Transparent



Opera Bar 65

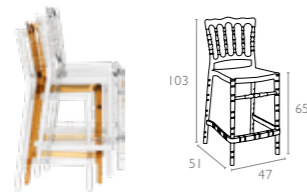


Stacking wedding bar stool h.65 cm for indoor and outdoor use in clear or shiny polycarbonate. Scratch resistant, UV - resistant.

074 Opera Bar 65

CATAS Testato - Tested

Made with
Makrolon®
The high-tech polycarbonate



Colors



Glossy White

Amber Transparent

Clear Transparent



Chiavari Bar 75

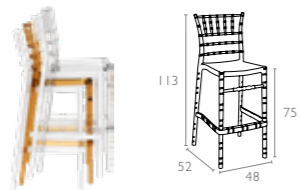


Stacking wedding bar stool h.75 cm for indoor and outdoor use in clear or shiny polycarbonate. Scratch resistant, UV - resistant.

083 Chiavari Bar 75

CATAS Testato - Tested

Made with
Makrolon®
The high-tech polycarbonate



Colors



Glossy White

Amber Transparent

Clear Transparent



Chiavari Bar 65

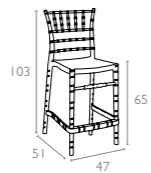


Stacking wedding bar stool h.65 cm for indoor and outdoor use in clear or shiny polycarbonate. Scratch resistant, UV - resistant.

084 Chiavari Bar 65

CATAS Testato - Tested

Made with **Makrolon**[®]
The high-tech polycarbonate



Colors



Glossy White

Amber Transparent

Clear Transparent





Stacking bar stool h.75 cm for indoor and outdoor use in shiny technopolymer PA6 nylon or clear polycarbonate. Scratch resistant, self - extinguish classification V2, UV - resistant.

037 Fox 75

CATAS Testato - Tested

Made with
Makrolon®
The high-tech polycarbonate



Colors



Glossy White

Glossy Red

Black Transparent

Amber
Transparent

Smoke Grey
Transparent



Clear Transparent





Stacking bar stool h.65 cm for indoor and outdoor use in shiny technopolymer PA6 nylon or clear polycarbonate. Scratch resistant, self - extinguish classification V2, UV - resistant.

036 Fox 65

CATAS Testato - Tested

Made with
Makrolon®
The high-tech polycarbonate



Colors



Glossy White



Glossy Red



Black Transparent



Clear Transparent



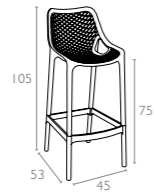
Air Bar 75



Air Bar stool h.75 cm is produced with a single injection of polypropylene reinforced with glass fiber obtained by means of the latest generation of air moulding technology with neutral tones. For indoor and outdoor use.

068 Air Bar 75

CATAS Testato - Tested



Colors



White

Black

Dark Grey

Red

Taupe



Tropical Green



Orange



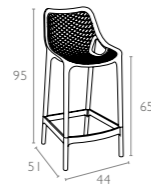
Air Bar 65



Air Bar stool h.65 cm is produced with a single injection of polypropylene reinforced with glass fiber obtained by means of the latest generation of air moulding technology with neutral tones. For indoor and outdoor use.

067 Air Bar 65

CATAS Testato - Testet



Colors



White Black Dark Grey Red Taupe



Tropical Green Orange

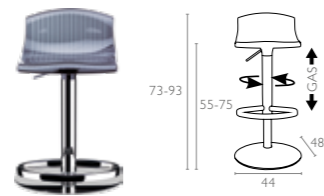




Revolving stool with adjustable height with gas piston. Base and column in stainless steel. Seat in recyclable polycarbonate. For indoor use.

042 Aria

Made with
Makrolon®
The high-tech polycarbonate



Colors



Glossy White

Red Transparent

Amber Transparent

Black Transparent

Clear Transparent

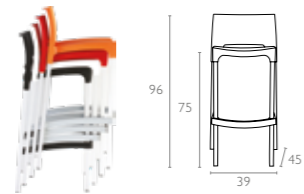


Gio 75



Stacking bar stool with recyclable polypropylene seat and backrest and square anodized aluminium legs. Diameter 25x25 mm. For indoor and outdoor use.

035 Gio 75



Colors



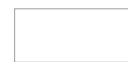
Black

Light Green

Orange

Red

Beige



White





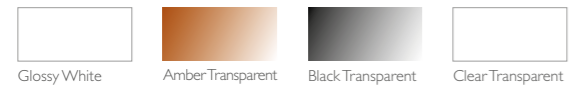
Stacking side table for indoor and outdoor use in clear polycarbonate. UV - resistant.

065 Queen



Made with
Makrolon®
The high-tech polycarbonate

Colors



Glossy White

Amber Transparent

Black Transparent

Clear Transparent

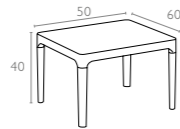


Sky Side Table



Sky Side Table is made of durable weather-resistant resin. Non-metallic frame will never unravel, rust or decay. It is UV protected which insures the colors will not fade. Can be disassembled. For indoor and outdoor use.

109 Sky Side Table



Colors



White

Black

Dark Grey

Taupe

Red



Yellow



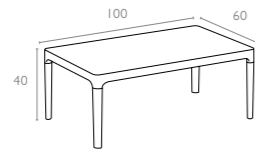
Sky Lounge Table



Sky Table is made of durable weather-resistant resin. Metallic frame will never unravel, rust or decay. It is UV protected which insures the colors will not fade. Can be disassembled. For indoor and outdoor use.

104 Sky Lounge Table

CATAS Testato - Tested



Colors



White Black Dark Grey Taupe Red



Yellow

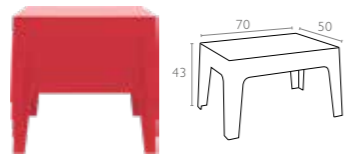


Box Table

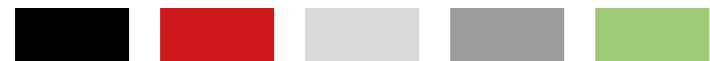


Stacking table in recyclable polypropylene.
For indoor and outdoor use.

064 Box Table



Colors



Black

Red

Silver Grey

Dark Grey

Tropical Green



Orange



White

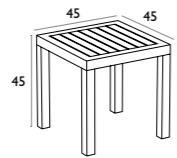


Ocean Side Table



Ocean Side Table is made of durable weather-resistant resin. Non-metallic frame will never unravel, rust or decay. It is UV protected which insures the colors will not fade. Can be disassembled. For indoor and outdoor use.

066 Ocean Side Table



Colors

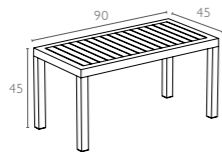


Ocean Table



Ocean Lounge Table is made of durable weather-resistant resin. Non-metallic frame will never unravel, rust or decay. It is UV protected which insures the colors will not fade. Can be disassembled. For indoor and outdoor use.

069 Ocean Table



Colors



Vegas Table

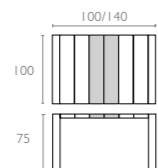


Extendible table from 100 to 140 cm in polypropylene reinforced with glass fiber. Easily expandable, giving you a choice of two size options. Smart extending mechanism makes it easy to adjust the table to your preferred size. For indoor and outdoor use with UV protection.



772 Vegas Table

CATAS Testato - Tested



Colors



White

Black

Dark Grey

Taupe



Vegas Table Medium

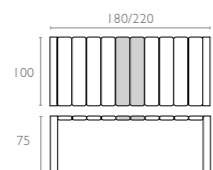


Extendible table from 180 to 220 cm in polypropylene reinforced with glass fiber. Easily expandable, giving you a choice of two size options. Smart extending mechanism makes it easy to adjust the table to your preferred size. For indoor and outdoor use with UV protection.



774 Vegas Table Medium

CATAS Testato - Tested



Colors



White



Black



Dark Grey



Taupe



Vegas Table XL

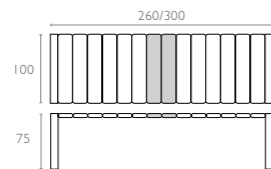


Extendible table from 260 to 300 cm in polypropylene reinforced with glass fiber. Easily expandable, giving you a choice of two size options. Smart extending mechanism makes it easy to adjust the table to your preferred size. For indoor and outdoor use with UV protection.



776 Vegas Table XL

CATAS Testato - Tested



Colors



White

Black

Dark Grey

Taupe



Sky Folding Table 60



Sky folding table is made of durable weather-resistant resin. Metallic frame will never unravel, rust or decay. It is UV protected which insures the colors will not fade. Can be disassembled. For indoor and outdoor use.

114 Sky Folding Table 60



Colors



White

Black

Dark Grey

Taupe

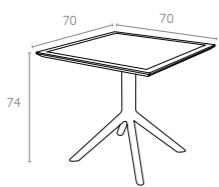


Sky Table 70



Sky Table is made of durable weather-resistant resin. Metallic frame will never unravel, rust or decay. It is UV protected which insures the colors will not fade. Can be disassembled. For indoor and outdoor use.

108 Sky Table 70



Colors



White

Black

Dark Grey

Taupe

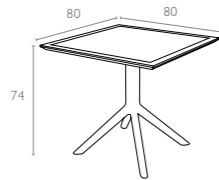


Sky Table 80



Sky Table is made of durable weather-resistant resin. Metallic frame will never unravel, rust or decay. It is UV protected which insures the colors will not fade. Can be disassembled. For indoor and outdoor use.

106 Sky Table 80



Colors



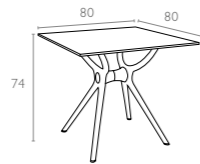
Air Table 80



Table with plastic legs with HPL compact laminated tops 12 mm available in white and black. For indoor and outdoor use. Can be disassembled.

** Dark colors not recommended in direct sunlight.*

700 Air Table 80



Colors



White



Black



Air Table I 40



Table with plastic legs with HPL compact laminated tops 12 mm available in white and black. For indoor and outdoor use. Can be disassembled.

** Dark colors not recommended in direct sunlight.*

705 Air Table I 40



Colors



White



Black



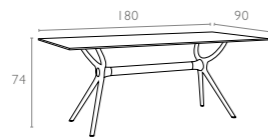
Air Table 180



Table with plastic legs with HPL compact laminated tops 12 mm available in white and black. For indoor and outdoor use. Can be disassembled.

** Dark colors not recommended in direct sunlight.*

715 Air Table 180



Colors



White



Black



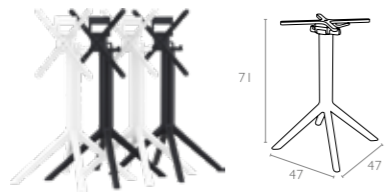
Sky Folding Legs



Sky folding leg is made of durable weather-resistant resin. Metallic frame will never unravel, rust or decay. It is UV protected which insures the colors will not fade. Can be disassembled and suitable for werzalit or HPL compact tops. For indoor and outdoor use.

118 Sky Folding Legs

Top min: 50x50 cm
Top max: 70x70 cm



Colors



White



Black



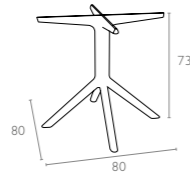
Sky Legs



Sky leg is made of durable weather-resistant resin. Metallic frame will never unravel, rust or decay. It is UV protected which insures the colors will not fade. Can be disassembled and suitable for werzalit or HPL compact tops. For indoor and outdoor use.

107 Sky Legs

Top min : 70x70 cm
Top max : 90x90 cm



Colors



White

Black

Dark Grey

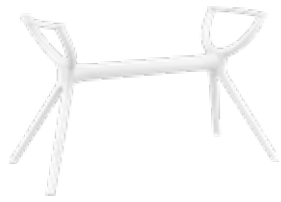
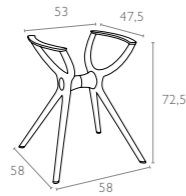
Taupe





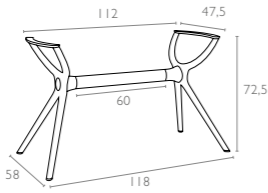
335 Air Legs Small

* Top min. 70x70 cm, Top max. 90x90 cm



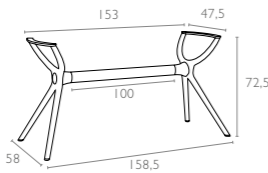
336 Air Legs Medium

* Top min. 70x120 cm, Top max. 80x160 cm



337 Air Legs XL

* Top min 90x180 cm, Top max 100x200 cm



Air Legs are made up of polypropylene reinforced with glass fiber with the latest generation of air moulding thermoplastic injection. For indoor and outdoor use. Can be disassembled.

Colors



White



Black



Octopus 60



Octopus table is made of durable weather-resistant resin. Metallic frame will never unravel, rust or decay. It is UV protected which insures the colors will not fade. Can be disassembled. For indoor and outdoor use.

160 Octopus 60



Colors



Black

Dark Grey

Silver Grey

Taupe

White



Yellow



Octopus Bar



Octopus Bar table is made of durable weather-resistant resin. Metallic frame will never unravel, rust or decay. It is UV protected which insures the colors will not fade. Can be disassembled. For indoor and outdoor use.

161 Octopus Bar



Colors



Black

Dark Grey

Taupe

White



Sky Folding Bar Table 60



Sky folding bar table is made of durable weather-resistant resin. Metallic frame will never unravel, rust or decay. It is UV protected which insures the colors will not fade. Can be disassembled. For indoor and outdoor use.

116 Sky Folding Bar Table 60



Colors

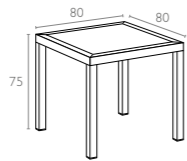


Ares 80

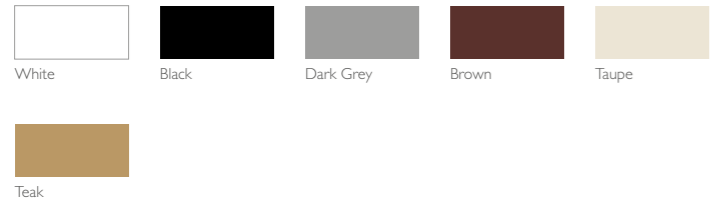


Ares 80 table is made of durable weather-resistant resin. Non-metallic frame will never unravel, rust or decay. It is UV protected which insures the colors will not fade. Can be disassembled. For indoor and outdoor use.

164 Ares 80



Colors

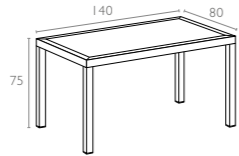


Ares 140

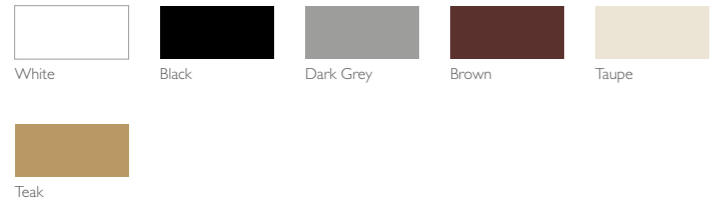


Ares 140 table is made of durable weather-resistant resin. Non-metallic frame will never unravel, rust or decay. It is UV protected which insures the colors will not fade. Can be disassembled. For indoor and outdoor use.

186 Ares 140

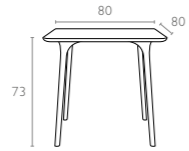


Colors





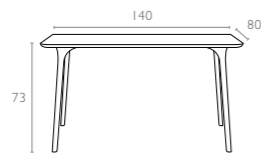
685 Maya 80



675 Maya 120



690 Maya 140



HPL compact laminated tops
12 mm with the latest generation of
air moulding thermoplastic legs.
For indoor and outdoor use.
Can be disassembled.



Colors



White

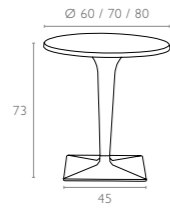








500 - 510 - 520 Ice



550 - 560 Ice

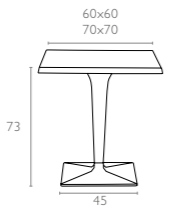


Table with clear transparent polycarbonate leg and painted aluminium base. Werzalit tops, resistant to outdoor use, available in white, black and silver grey. For indoor and outdoor use.



Colors



White



Black



Silver Grey



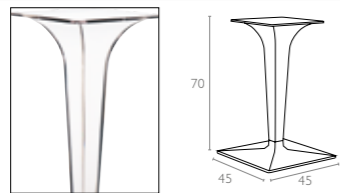


Ice Leg & Base



Clear transparent polycarbonate leg and painted aluminium base.
For indoor and outdoor use.

310 Ice Leg & Base



Made with
Makrolon[®]
The high-tech polycarbonate

Colors



Clear Transparent

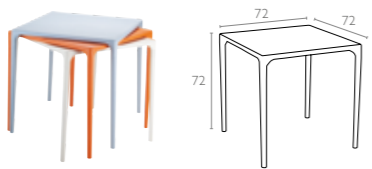


Mango



Stacking table with the latest generation of air moulding thermoplastic injection. For indoor and outdoor use.

800 Mango



Colors

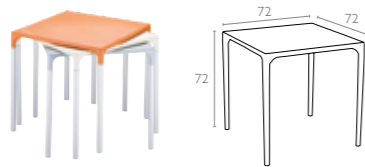


Mango Alu



Stacking table with the latest generation of air moulding thermoplastic injection with legs in anodized aluminium. For indoor and outdoor use.

758 Mango Alu



Colors



White

Beige

Orange

Silver Grey



Forza



Folding table with legs in anodized aluminium. Diameter 30 mm. Table top in recyclable polypropylene. For indoor and outdoor use.

770 Forza



Colors

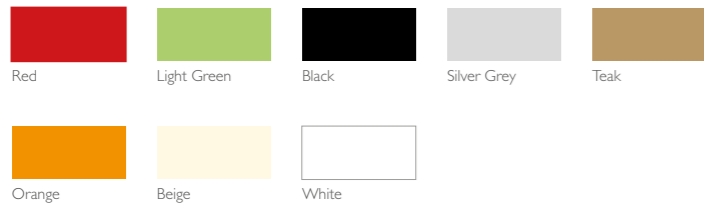
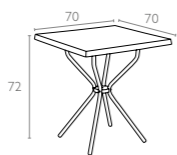




Table top in recyclable polypropylene, anodized aluminium legs.
Diameter 25 mm. For indoor and outdoor use. Can be disassembled.

750 Sortie



Colors



Black

Red

Light Green

Orange

Beige



White

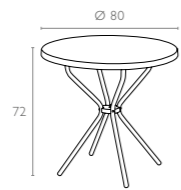


Poppy 80



Table top in recyclable polypropylene, anodized aluminium legs.
Diameter 25 mm. For indoor and outdoor use. Can be disassembled.

720 Poppy 80



Colors



Black

Red

Light Green

Orange

Beige



White

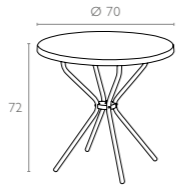


Elfo 70

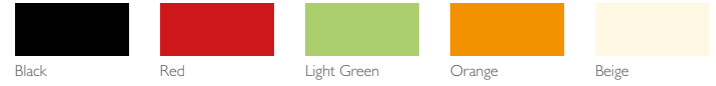


Table top in recyclable polypropylene, anodized aluminium legs.
 Diameter 25 mm. For indoor and outdoor use. Can be disassembled.

710 Elfo 70



Colors



Dodo

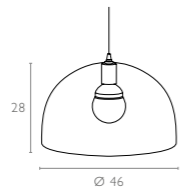


Suspension lamp in polycarbonate with 25W energy saving lamp. The diffuser can be removed without dismantling the electrical body, for an easy fitting and removal.

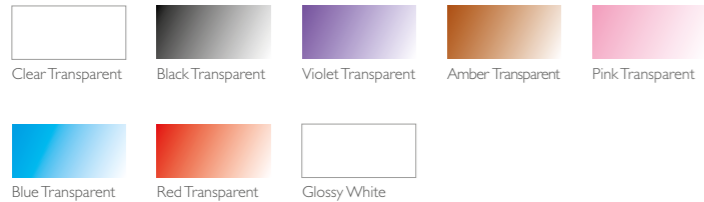
415 Dodo



Made with **Makrolon**[®]
The high-tech polycarbonate



Colors



Nova

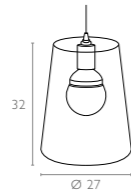


Suspension lamp in polycarbonate with 25W energy saving lamp. The diffuser can be removed without dismantling the electrical body, for an easy fitting and removal.

410 Nova



Made with **Makrolon**[®]
The high-tech polycarbonate



Colors

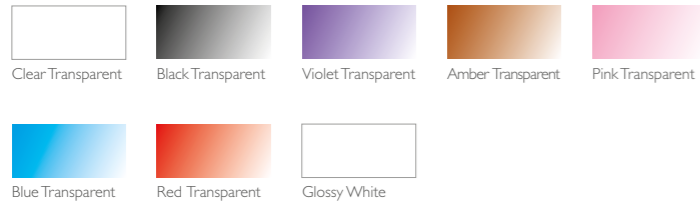


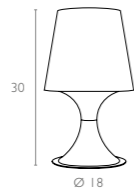


Table lamp made of transparent or coloured injected polycarbonate, with 40W lamp. Perfect gift idea.

420 Smart

CE

Made with
Makrolon®
The high-tech polycarbonate



Colors



Clear Transparent

Black Transparent

Violet Transparent

Amber Transparent

Pink Transparent



Blue Transparent

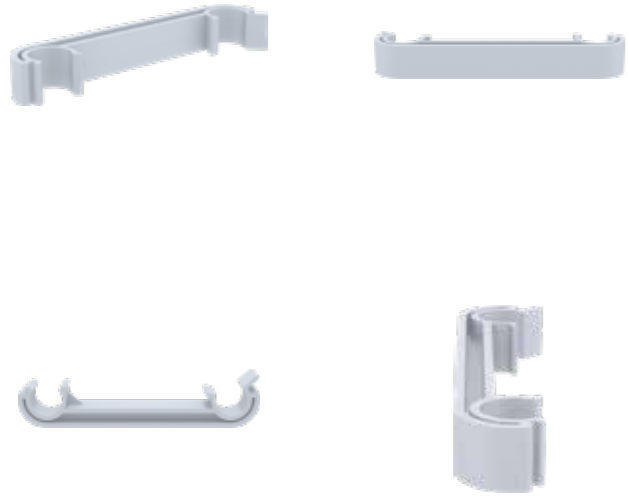


Red Transparent



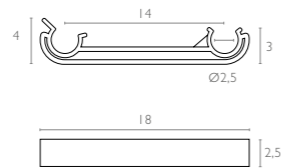
Glossy White





Link linking device in polypropylene to be fixed on the frame.
Suitable for all round legs \varnothing 25mm.

097 Link



Colors



Silver Grey



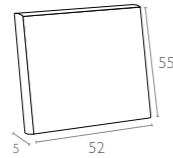
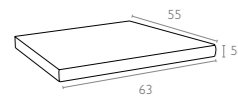
Artemis XL Cushions



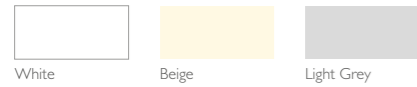
5 cm thick seat and backrest cushion covered with polyester fabric and finished with piping. Cushion is specially designed for Artemis XL armchair.

899 Artemis XL Seat Cushion

900 Artemis XL Backrest Cushion



Cushion Colors



White Beige Light Grey



Mykonos Cushions



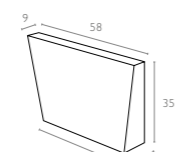
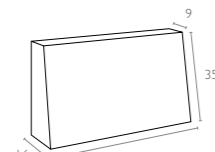
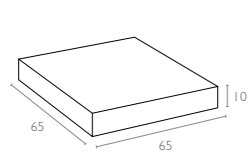
10 cm thick cushion covered with Etisilk polyester fabric and finished with piping. Cushions are specially designed for Mykonos Lounge Set. Water resistant with UV.



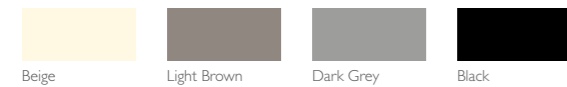
141 Mykonos Seat Cushion

142 Mykonos Backrest Cushion

143 Mykonos Corner Cushion



Cushion Colors



Beige Light Brown Dark Grey Black



102 SKY

Sky armchair is produced with recyclable polypropylene seat and legs reinforced with glass fiber. For indoor and outdoor use. Can be disassembled.

CATAS
Testato - Testad



White



Dark Grey



Black



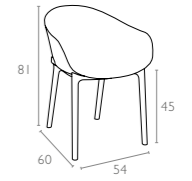
Taupe



Red



Yellow



103 SKY LOUNGE

Sky lounge chair is produced with recyclable polypropylene seat and legs reinforced with glass fiber. For indoor and outdoor use. Can be disassembled.

CATAS
Testato - Testad



White



Dark Grey



Black



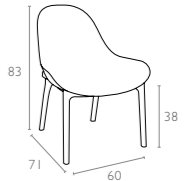
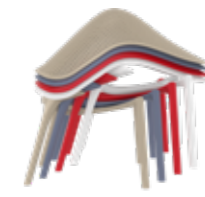
Taupe



Red



Yellow



127 MONNA

Monna chair is produced with a single injection of polypropylene reinforced with glass fiber obtained by means of the latest generation of air moulding technology with neutral tones. For indoor and outdoor use.

CATAS
Testato - Testad



White



Dark Grey



Black



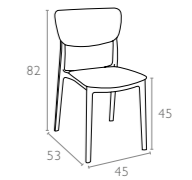
Taupe



Red



Olive Green



126 LISA

Lisa armchair is produced with a single injection of polypropylene reinforced with glass fiber obtained by means of the latest generation of air moulding technology with neutral tones. For indoor and outdoor use.

CATAS
Testato - Testad



White



Dark Grey



Black



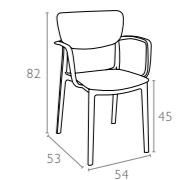
Taupe



Red



Olive Green



129 LUCY

Lucy chair is produced with a single injection of polypropylene reinforced with glass fiber obtained by means of the latest generation of air moulding technology with neutral tones. For indoor and outdoor use.

CATAS
Testato - Testad



White



Dark Grey



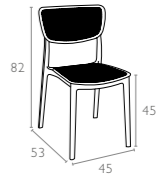
Black



Taupe



Olive Green



128 LOFT

Loft armchair is produced with a single injection of polypropylene reinforced with glass fiber obtained by means of the latest generation of air moulding technology with neutral tones. For indoor and outdoor use.

CATAS
Testato - Testad



White



Dark Grey



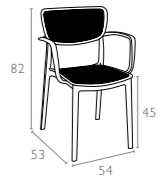
Black



Taupe



Olive Green



085 MILA

Mila armchair is produced with a single injection of polypropylene reinforced with glass fiber obtained by means of the latest generation of air moulding technology with neutral tones. For indoor and outdoor use.

CATAS
Testato - Testad



White



Dark Grey



Black



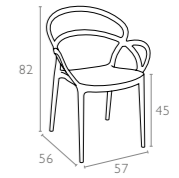
Taupe



Red



Yellow



086 PIA

Pia chair is produced with a single injection of polypropylene reinforced with glass fiber obtained by means of the latest generation of air moulding technology with neutral tones. For indoor and outdoor use.

CATAS
Testato - Testad



White



Dark Grey



Black



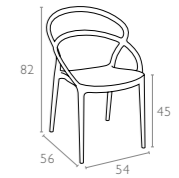
Taupe



Red



Yellow



088 SUNSET

Sunset chair is produced with a single injection of polypropylene reinforced with glass fiber obtained by means of the latest generation of air moulding technology with neutral tones. For indoor and outdoor use.



White



Dark Grey



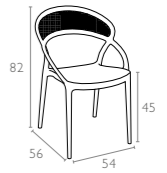
Black



Brown



Taupe



093 PLUS

Plus armchair is produced with a single injection of polypropylene reinforced with glass fiber obtained by means of the latest generation of air moulding technology with neutral tones. For indoor and outdoor use.



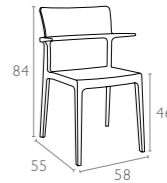
White



Black



Red



092 SNOW

Snow chair is produced with a single injection of polypropylene reinforced with glass fiber obtained by means of the latest generation of air moulding technology with neutral tones. For indoor and outdoor use.



White



Dark Grey



Black



Taupe



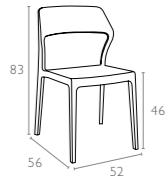
Red



Yellow



Olive Green



090 MOON

Stacking chair with the latest generation of air moulding thermoplastic injection. Seat in polypropylene reinforced with glass fiber; backrest in transparent polycarbonate. For indoor and outdoor use.



White Glossy White



White Amber Transparent



White Red Transparent



White Clear Transparent



Black Clear Transparent



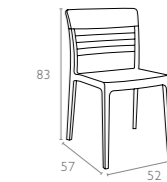
Black Black Transparent



Black Amber Transparent

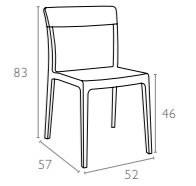
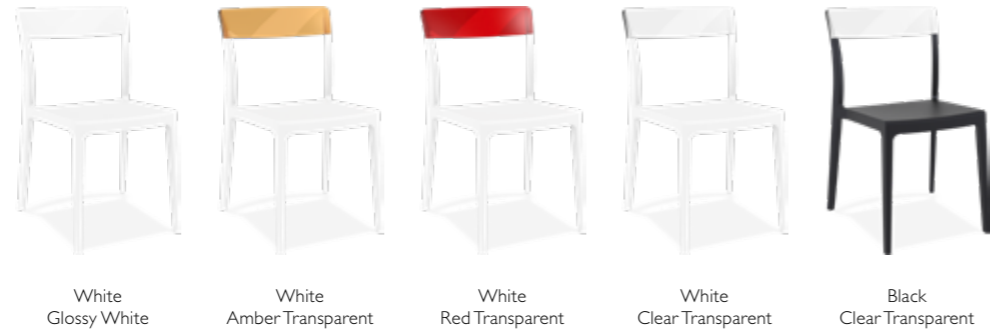


Black Red Transparent



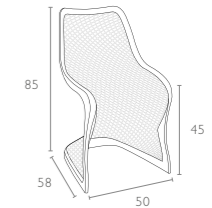
091 FLASH

Stacking chair with the latest generation of air moulding thermoplastic injection. Seat in polypropylene reinforced with glass fiber, backrest in transparent polycarbonate. For indoor and outdoor use.



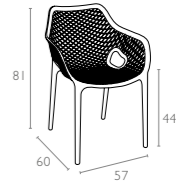
048 BLOOM

Bloom chair is produced with a single injection of polypropylene reinforced with glass fiber obtained by means of the latest generation of air moulding technology with neutral tones. For indoor and outdoor use.



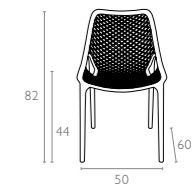
007 AIR XL

Air XL armchair is produced with a single injection of polypropylene reinforced with glass fiber obtained by means of the latest generation of air moulding technology with neutral tones. For indoor and outdoor use.



014 AIR

Air chair is produced with a single injection of polypropylene reinforced with glass fiber obtained by means of the latest generation of air moulding technology with neutral tones. For indoor and outdoor use.



039 MIRANDA

Miranda chair is produced with a single injection of polypropylene reinforced with glass fiber obtained by means of the latest generation of air moulding technology with neutral tones. For indoor and outdoor use.



White



Dark Grey



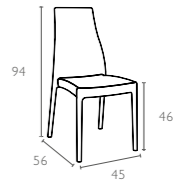
Black



Brown



Taupe



054 SOHO

Soho chair is produced with a single injection of polypropylene reinforced with glass fiber obtained by means of the latest generation of air moulding technology with neutral tones. For indoor and outdoor use.



White



Dark Grey



Black



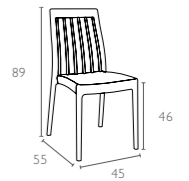
Brown



Taupe



Red



050 JOSEPHINE

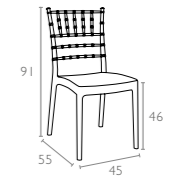
Josephine wedding chair is produced with a single injection of polypropylene reinforced with glass fiber obtained by means of the latest generation of air moulding technology with neutral tones. For indoor and outdoor use.



White



Black



044 NAPOLEON

Napoleon wedding chair is produced with a single injection of polypropylene reinforced with glass fiber obtained by means of the latest generation of air moulding technology with neutral tones. For indoor and outdoor use.



White



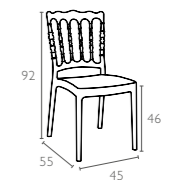
Silver Grey



Black



Gold



061 OPERA

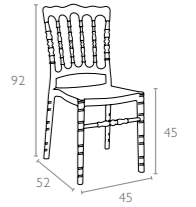
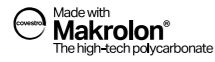
Stacking wedding chair for indoor and outdoor use in clear or shiny polycarbonate. Scratch resistant, UV - resistant.



Glossy White

Amber Transparent

Clear Transparent



071 CHIAVARI

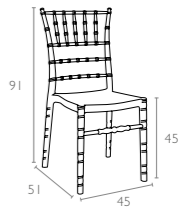
Stacking wedding chair for indoor and outdoor use in clear or shiny polycarbonate. Scratch resistant, UV - resistant.



Glossy White

Amber Transparent

Clear Transparent



052 CRYSTAL

Stacking armchair for indoor and outdoor use in clear polycarbonate moulded with gas technology of the second generation. Scratch resistant, UV - resistant.



Glossy White

Clear Transparent

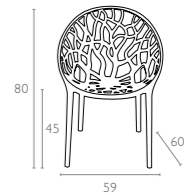
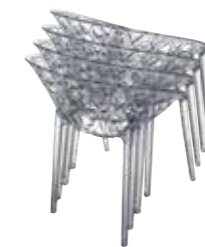
Smoke Grey Transparent

Black Transparent

Orange Transparent

Amber Transparent

Red Transparent



032 DEJAVU

Stacking armchair for indoor and outdoor use in shiny technopolymer PA6 nylon or clear polycarbonate moulded with gas technology of the second generation. Scratch resistant, self - extinguish classification V2, UV - resistant.



Glossy White

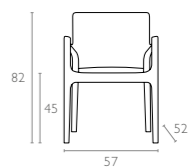
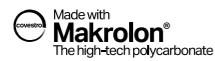
Glossy Red

Clear Transparent

Smoke Grey Transparent

Black Transparent

Amber Transparent



034 ELIZABETH

Stacking chair for indoor and outdoor use in shiny technopolymer PA6 nylon or clear polycarbonate. Scratch resistant, self - extinguish classification V2, UV - resistant.

* On request with cushion.



Glossy White



Glossy Red



Glossy Black



Clear Transparent



Black Transparent



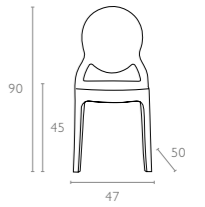
Amber Transparent



Pink Transparent

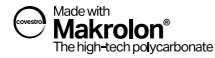


* Black Transparent



051 BABY ELIZABETH

Stacking children chair Baby Elizabeth for indoor and outdoor use in clear polycarbonate. Scratch resistant, UV - resistant.



Glossy White



Clear Transparent



Pink Transparent



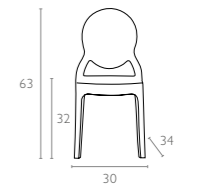
Violet Transparent



Red Transparent



Blue Transparent



053 ARTHUR

Stacking armchair for indoor and outdoor use in shiny technopolymer PA6 nylon or clear polycarbonate. Scratch resistant, self - extinguish classification V2, UV - resistant.



Glossy White



Glossy Red



Glossy Black



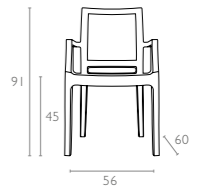
Clear Transparent



Black Transparent



Amber Transparent



005 BO

Stacking chair for indoor and outdoor use in clear or shiny polycarbonate. Scratch resistant, UV - resistant.



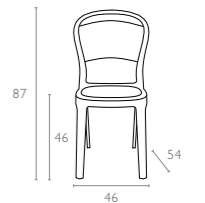
Glossy White



Glossy Black



Clear Transparent



021 BEE

Stacking chair for indoor and outdoor use in clear or shiny polycarbonate. Scratch resistant, UV - resistant.



Glossy White



Glossy Black



Clear Transparent



Black Transparent

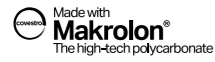
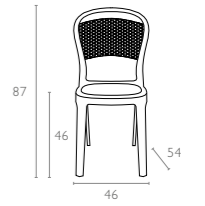


Amber Transparent



Red Transparent

Design By
LO
ILANIT OVADYA



055 Miss BIBI

Stacking chair with the latest generation of air moulding thermoplastic injection. Seat in polypropylene reinforced with glass fiber; backrest in transparent polycarbonate. For indoor and outdoor use.



White Clear Transparent



White Amber Transparent



White Black Transparent



White Red Transparent



White Violet Transparent



Dark Grey Clear Transparent



Dark Grey Smoke Grey Transparent



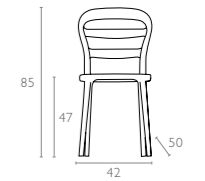
Black Clear Transparent



Black Amber Transparent



Black Black Transparent



056 Mr BOBO

Stacking chair with the latest generation of air moulding thermoplastic injection. Seat in polypropylene reinforced with glass fiber; backrest in transparent polycarbonate. For indoor and outdoor use.



White Clear Transparent



White Amber Transparent



White Black Transparent



Dark Grey Clear Transparent



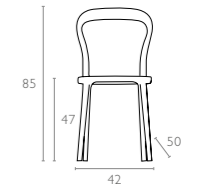
Dark Grey Smoke Grey Transparent



Black Clear Transparent



Black Black Transparent



059 CARMEN

Stacking armchair with the latest generation of air moulding thermoplastic injection. Seat in polypropylene reinforced with glass fiber; backrest in transparent polycarbonate. For indoor and outdoor use.



White Glossy White



White Clear Transparent



White Amber Transparent



White Black Transparent



White Red Transparent



White Violet Transparent



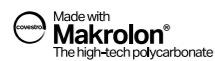
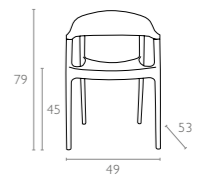
Black Clear Transparent



Black Black Transparent



Black Amber Transparent



057 ALLEGRA

Recyclable polycarbonate main body.
Legs frame in tubular chrome steel.
Stackable. For indoor use.



Glossy
White



Clear
Transparent



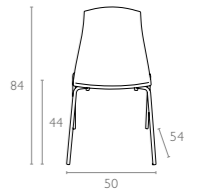
Black
Transparent



Amber
Transparent



Red
Transparent



Made with
Makrolon®
The high-tech polycarbonate



096 ALLEGRA-PP

Recyclable polycarbonate main body.
Legs frame in polypropylene.
For indoor and outdoor use.
Can be disassembled.



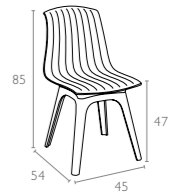
White
Glossy White



Black
Black Transparent



Brown
Glossy White



Made with
Makrolon®
The high-tech polycarbonate



094 MIO-PP

Mio-PP chair is produced with
recyclable polypropylene seat and
legs reinforced with glass fiber.
For indoor and outdoor use.
Can be disassembled.



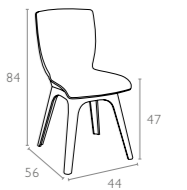
White
White



Black
Black



Brown
White



046 MIO

Stacking chair with recyclable
polypropylene seat and backrest and
painted steel legs. For indoor use.



White



Beige



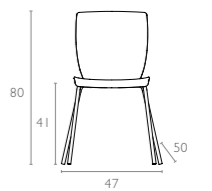
Red



Orange



Black



025 MAYA

Stacking chair with the latest generation of air moulding thermoplastic injection. For indoor and outdoor use.



White



Orange



Silver Grey



Black



Light Blue



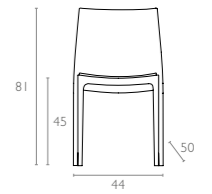
Dark Grey



Tropical Green



Olive Green



Testato - Testad



028 DIVA

Diva armchair is produced with a single injection of polypropylene reinforced with glass fiber obtained by means of the latest generation of air moulding technology with neutral tones. For indoor and outdoor use.



White



Orange



Silver Grey



Black



Light Blue



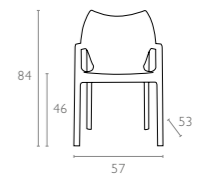
Dark Grey



Red



Tropical Green



Testato - Testad



058 BOX

Recyclable polypropylene stacking armchair, strong and stable. Suitable for outdoor contract use.



White



Silver Grey



Dark Grey



Black



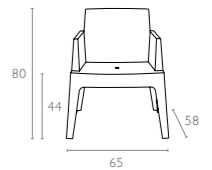
Red



Orange



Tropical Green



Testato - Testad



063 BOX SOFA

Recyclable polypropylene stackable sofa, very sturdy and stable. Suitable for outdoor contract use.



White



Silver Grey



Dark Grey



Black



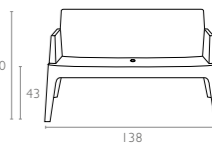
Red



Orange



Tropical Green



Testato - Testad



009 ARES

Ares chair is produced with a single injection of polypropylene reinforced with glass fiber obtained by means of the latest generation of air moulding technology with neutral tones. For indoor and outdoor use.



White



Taupe



Teak



Brown



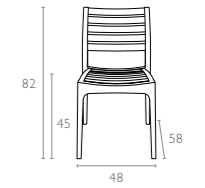
Silver Grey



Dark Grey



Black



011 ARTEMIS

Artemis armchair is produced with a single injection of polypropylene reinforced with glass fiber obtained by means of the latest generation of air moulding technology with neutral tones. For indoor and outdoor use.



White



Taupe



Teak



Brown



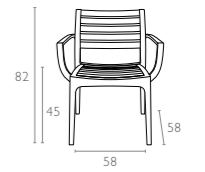
Silver Grey



Dark Grey



Black



004 ARTEMIS XL

Artemis XL Lounge armchair is stackable and produced with a single injection of polypropylene reinforced with glass fiber, for indoor and outdoor use with or without cushion and non-slip feet. The Artemis collection also includes a coffee table, in various sizes, designed to match the styling silhouette of the chair to perfection.



White



Taupe



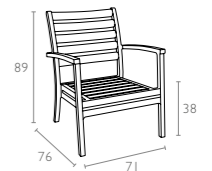
Silver Grey



Dark Grey



Black



018 TIFFANY

Tiffany chair is produced with a single injection of polypropylene reinforced with glass fiber obtained by means of the latest generation of air moulding technology with neutral tones. Stackable. For indoor and outdoor use.



White



Orange



Silver Grey



Black



Light Blue



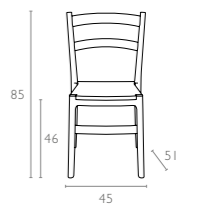
Dark Grey



Brown



Tropical Green



019 TIFFANY-S

Tiffany-S chair is produced with a single injection of polypropylene reinforced with glass fiber obtained by means of the latest generation of air moulding technology with neutral tones. Stackable. For indoor and outdoor use.

CATAS
Testato - Testad



White



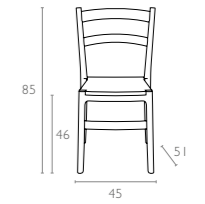
Light Blue



Dark Grey



Brown



026 LUCCA

Stacking chair with the latest generation of air moulding thermoplastic injection. For indoor and outdoor use.

CATAS
Testato - Testad



White



Orange



Silver Grey



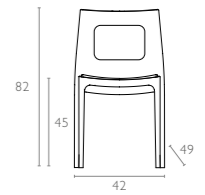
Light Blue



Dark Grey



Tropical Green



029 LUCCA-T

Stacking chair with the latest generation of air moulding thermoplastic injection. Back in transparent polycarbonate. For indoor and outdoor use.

CATAS
Testato - Testad

Made with
Makrolon®
The high-tech polycarbonate



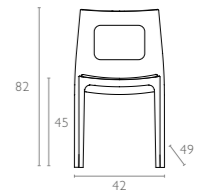
White



Orange



Light Blue



047 DOLCE

Stacking armchair with recyclable polypropylene seat and backrest and anodized aluminium legs. Diameter 25 mm. For indoor and outdoor use.



White



Beige



Red



Orange



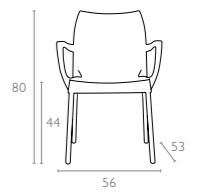
Light Green



Dark Grey



Black



049 VITA

Stacking chair with recyclable polypropylene seat and backrest and anodized aluminium legs. Diameter 25 mm. For indoor and outdoor use.



White



Beige



Red



Orange



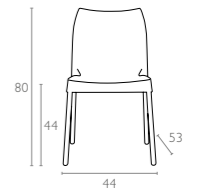
Light Green



Dark Grey



Black

**043 ROMEO**

Stacking armchair with recyclable polypropylene seat and backrest and anodized aluminium legs. Diameter 25 mm. For indoor and outdoor use.



White



Beige



Red



Orange



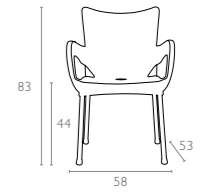
Light Green



Black



Blue

**045 JULIETTE**

Stacking chair with recyclable polypropylene seat and backrest and anodized aluminium legs. Diameter 25 mm. For indoor and outdoor use.



White



Beige



Red



Orange



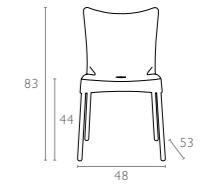
Light Green



Black



Blue

**041 GALA**

Stacking armchair in anodized aluminium with seat and back in recyclable polypropylene with latest generation of air moulding thermoplastic injection. Diameter 25 mm. For indoor and outdoor use.



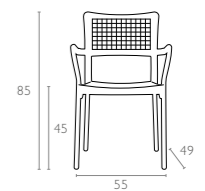
White



Orange



Teak



040 BELLA

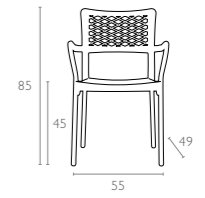
Stacking armchair in anodized aluminium with seat and back in recyclable polypropylene with latest generation of air moulding thermoplastic injection. Diameter 25 mm. For indoor and outdoor use.



White

Orange

Teak



089 PACIFIC

Sunlounger without arms, tubular frame in resin reinforced with glass fiber and cover in breathable synthetic fabric (replaceable). Stackable, back reclining in 5 positions, with non-slip feet and small wheels.



White
White

White
Taupe

White
Yellow

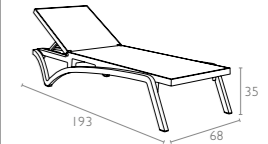
White
Turquoise



White
Blue

Dark Grey
Black

Black
Black



133 MYKONOS LOUNGE SET XL

Mykonos Lounge Set XL is designed for easy self assembly, it is made of durable weather-resistant resin reinforced with glass fiber. Non-metallic frame will never unravel, rust or decay. It is UV protected which insures the colors will not fade. Can be disassembled. For indoor and outdoor contract use.



White

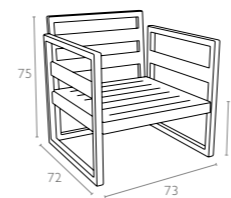


Silver Grey

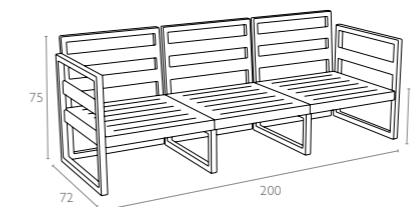


Taupe

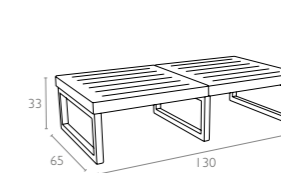
Mykonos
Lounge Armchair
2 pcs



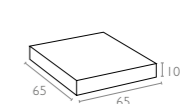
Mykonos
Lounge Sofa XL
1 pcs



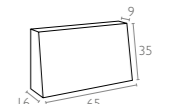
Mykonos
Lounge Table XL
1 pcs



Mykonos
Seat Cushion
5 pcs



Mykonos
Backrest Cushion
5 pcs



* Can be purchased with or without cushions.



132 MYKONOS LOUNGE SET

Mykonos Lounge Set is designed for easy self assembly, it is made of durable weather-resistant resin reinforced with glass fiber. Non-metallic frame will never unravel, rust or decay. It is UV protected which insures the colors will not fade. Can be disassembled. For indoor and outdoor contract use.



White



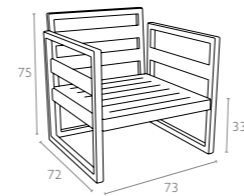
Silver Grey



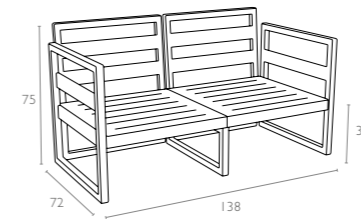
Taupe



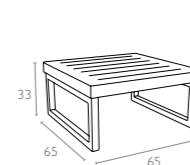
Mykonos Lounge Armchair
2 pcs



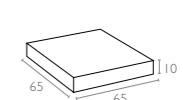
Mykonos Lounge Sofa
1 pcs



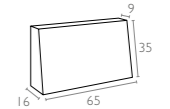
Mykonos Lounge Table
1 pcs



Mykonos Seat Cushion
4 pcs



Mykonos Backrest Cushion
4 pcs



* Can be purchased with or without cushions.



134 MYKONOS LOUNGE CORNER SET

Mykonos Lounge Corner Set is designed for easy self assembly, it is made of durable weather-resistant resin reinforced with glass fiber. Non-metallic frame will never unravel, rust or decay. It is UV protected which insures the colors will not fade. Can be disassembled. For indoor and outdoor contract use.



White



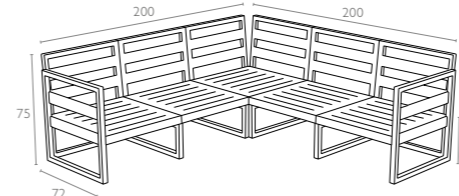
Silver Grey



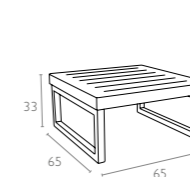
Taupe



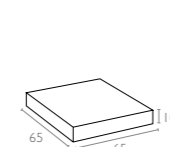
Mykonos Lounge Corner
1 pcs



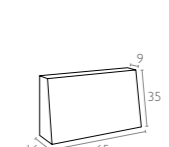
Mykonos Lounge Table
1 pcs



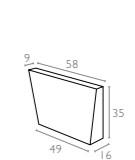
Mykonos Seat Cushion
5 pcs



Mykonos Backrest Cushion
5 pcs



Mykonos Corner Cushion
1 pcs



* Can be purchased with or without cushions.



131 MYKONOS LOUNGE ARMCHAIR

Mykonos Lounge Armchair is designed for easy self assembly, it is made of durable weather-resistant resin reinforced with glass fiber. Non-metallic frame will never unravel, rust or decay. It is UV protected which insures the colors will not fade. Can be disassembled.

For indoor and outdoor contract use.



Testato - Tested



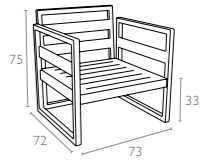
White



Taupe



Silver Grey



137 MYKONOS LOUNGE TABLE

Mykonos Lounge Table is made of durable weather-resistant resin. Non-metallic frame will never unravel, rust or decay. It is UV protected which insures the colors will not fade.

Can be disassembled.

For indoor and outdoor use.



Testato - Tested



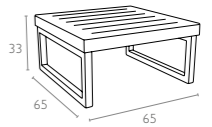
White



Taupe



Silver Grey



138 MYKONOS LOUNGE TABLE XL

Mykonos Lounge Table XL is made of durable weather-resistant resin. Non-metallic frame will never unravel, rust or decay. It is UV protected which insures the colors will not fade.

Can be disassembled.

For indoor and outdoor use.



Testato - Tested



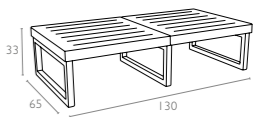
White



Taupe

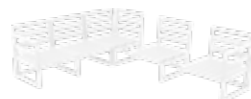


Silver Grey



136 MYKONOS EXTENSION PART

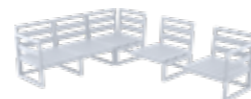
With the extension part you can add as many seats as you want to extend your corner set.



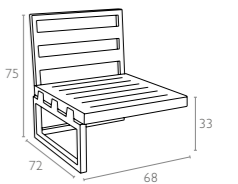
White



Taupe



Silver Grey



Testato - Tested

099 MAYA BAR 75

Maya stacking bar stool h.75 cm is produced with a single injection of polypropylene reinforced with glass fiber obtained by means of the latest generation of air moulding technology with neutral tones. For indoor and outdoor use.



White



Dark Grey



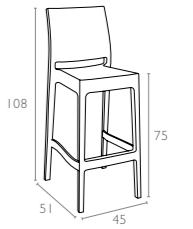
Black



Taupe



Olive Green



100 MAYA BAR 65

Maya stacking bar stool h.65 cm is produced with a single injection of polypropylene reinforced with glass fiber obtained by means of the latest generation of air moulding technology with neutral tones. For indoor and outdoor use.



White



Dark Grey



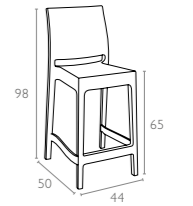
Black



Taupe



Olive Green



101 ARES BAR 75

Ares stacking bar stool h.75 cm is produced with a single injection of polypropylene reinforced with glass fiber obtained by means of the latest generation of air moulding technology with neutral tones. For indoor and outdoor use.



White



Dark Grey



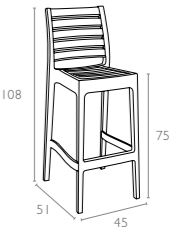
Black



Brown

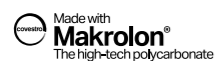


Taupe



073 OPERA BAR 75

Stacking wedding bar stool h.75 cm for indoor and outdoor use in clear or shiny polycarbonate. Scratch resistant, UV - resistant.



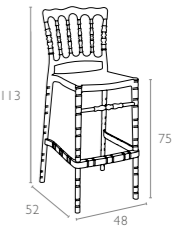
Glossy White



Amber Transparent



Clear Transparent



074 OPERA BAR 65

Stacking wedding bar stool h.65 cm for indoor and outdoor use in clear or shiny polycarbonate. Scratch resistant, UV - resistant.



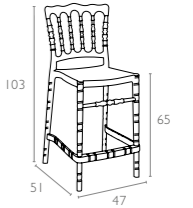
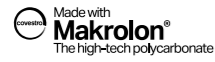
Glossy White



Amber Transparent



Clear Transparent



083 CHIAVARI BAR 75

Stacking wedding bar stool h.75 cm for indoor and outdoor use in clear or shiny polycarbonate. Scratch resistant, UV - resistant.



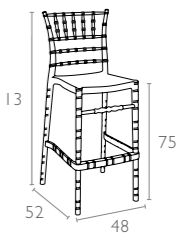
Glossy White



Amber Transparent



Clear Transparent



084 CHIAVARI BAR 65

Stacking wedding bar stool h.65 cm for indoor and outdoor use in clear or shiny polycarbonate. Scratch resistant, UV - resistant.



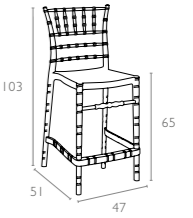
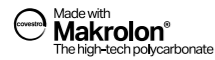
Glossy White



Amber Transparent



Clear Transparent



037 FOX 75

Stacking bar stool h.75 cm for indoor and outdoor use in shiny technopolymer PA6 nylon or clear polycarbonate. Scratch resistant, self - extinguish classification V2, UV - resistant.



Glossy White



Glossy Red



Clear Transparent



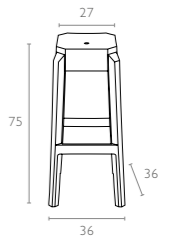
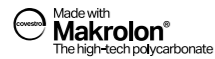
Smoke Grey Transparent



Amber Transparent



Black Transparent



036 FOX 65

Stacking bar stool h.65 cm for indoor and outdoor use in shiny technopolymer PA6 nylon or clear polycarbonate. Scratch resistant, self - extinguish classification V2, UV - resistant.

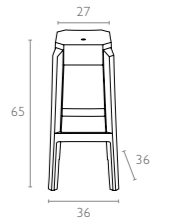
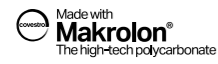


Glossy White

Glossy Red

Clear Transparent

Black Transparent



068 AIR BAR 75

Air Bar stool h.75 cm is produced with a single injection of polypropylene reinforced with glass fiber obtained by means of the latest generation of air moulding technology with neutral tones. For indoor and outdoor use.



White

Orange

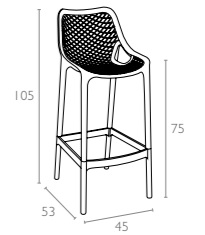
Dark Grey

Black

Taupe

Red

Tropical Green



067 AIR BAR 65

Air Bar stool h.65 cm is produced with a single injection of polypropylene reinforced with glass fiber obtained by means of the latest generation of air moulding technology with neutral tones. For indoor and outdoor use.



White

Orange

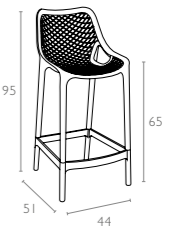
Dark Grey

Black

Taupe

Red

Tropical Green



042 ARIA

Revolving stool with adjustable height with gas piston. Base and column in stainless steel. Seat in recyclable polycarbonate. For indoor use.



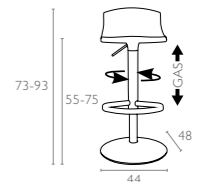
Glossy White

Clear Transparent

Black Transparent

Red Transparent

Amber Transparent



035 GIO 75

Stacking bar stool with recyclable polypropylene seat and backrest and square anodized aluminium legs. Diameter 25x25 mm. For indoor and outdoor use.



White



Beige



Red



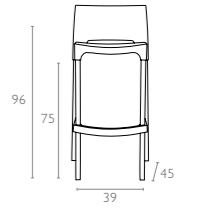
Orange



Light Green



Black



065 QUEEN

Stacking side table for indoor and outdoor use in clear polycarbonate. UV - resistant.



Glossy White



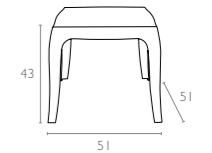
Clear Transparent



Black Transparent



Amber Transparent



109 SKY SIDE TABLE

Sky Side Table is made of durable weather-resistant resin. Non-metallic frame will never unravel, rust or decay. It is UV protected which insures the colors will not fade. Can be disassembled. For indoor and outdoor use.



White



Dark Grey



Black



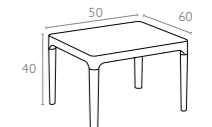
Taupe



Red



Yellow



104 SKY LOUNGE TABLE

Sky Table is made of durable weather-resistant resin. Metallic frame will never unravel, rust or decay. It is UV protected which insures the colors will not fade. Can be disassembled. For indoor and outdoor use.



White



Dark Grey



Black



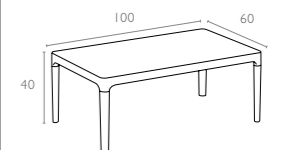
Taupe



Red



Yellow



064 BOX TABLE

Stacking table in recyclable polypropylene. For indoor and outdoor use.



White



Silver Grey



Dark Grey



Black



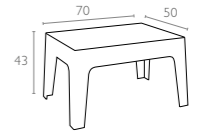
Red



Orange



Tropical Green



066 OCEAN SIDE TABLE

Ocean Side Table is made of durable weather-resistant resin. Non-metallic frame will never unravel, rust or decay. It is UV protected which insures the colors will not fade. Can be disassembled. For indoor and outdoor use.



White



Taupe



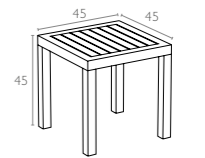
Silver Grey



Dark Grey



Black



069 OCEAN TABLE

Ocean Lounge Table is made of durable weather-resistant resin. Non-metallic frame will never unravel, rust or decay. It is UV protected which insures the colors will not fade. Can be disassembled. For indoor and outdoor use.



White



Taupe



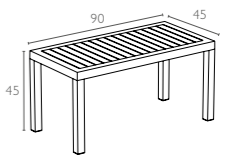
Silver Grey



Dark Grey



Black



772 VEGAS TABLE

Extendible table from 100 to 140 cm in polypropylene reinforced with glass fiber. Easily expandable, giving you a choice of two size options. Smart extending mechanism makes it easy to adjust the table to your preferred size. For indoor and outdoor use with UV protection.

100x100 / 100x140 cm



White



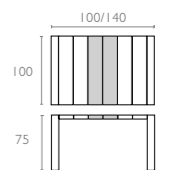
Taupe



Dark Grey



Black



774 VEGAS TABLE MEDIUM

Extendible table from 180 to 220 cm in polypropylene reinforced with glass fiber. Easily expandable, giving you a choice of two size options. Smart extending mechanism makes it easy to adjust the table to your preferred size. For indoor and outdoor use with UV protection.

100x180 / 100x220 cm

CATAS
Testato - Testad



White



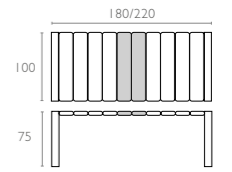
Taupe



Dark Grey



Black



776 VEGAS TABLE XL

Extendible table from 260 to 300 cm in polypropylene reinforced with glass fiber. Easily expandable, giving you a choice of two size options. Smart extending mechanism makes it easy to adjust the table to your preferred size. For indoor and outdoor use with UV protection.

100x260 / 100x300 cm

CATAS
Testato - Testad



White



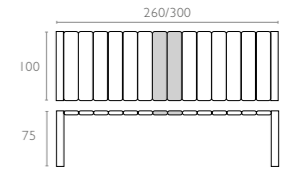
Taupe



Dark Grey



Black



114 SKY FOLDING TABLE 60

Sky folding table is made of durable weather-resistant resin. Metallic frame will never unravel, rust or decay. It is UV protected which insures the colors will not fade. Can be disassembled.

For indoor and outdoor use.

60x60 cm



White



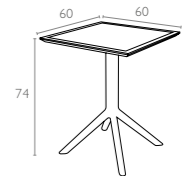
Taupe



Dark Grey



Black



108 SKY TABLE 70

Sky Table is made of durable weather-resistant resin. Metallic frame will never unravel, rust or decay. It is UV protected which insures the colors will not fade. Can be disassembled.

For indoor and outdoor use.

70x70 cm



White



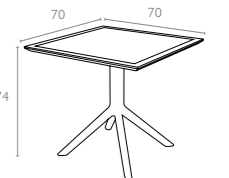
Taupe



Dark Grey



Black



106 SKY TABLE 80

Sky Table is made of durable weather-resistant resin. Metallic frame will never unravel, rust or decay. It is UV protected which insures the colors will not fade. Can be disassembled. For indoor and outdoor use.

80x80 cm



White



Taupe



Dark Grey



Black



700 AIR TABLE 80

Table with plastic legs with HPL compact laminated tops 12 mm available in white and black. For indoor and outdoor use. Can be disassembled.

** Dark colors not recommended in direct sunlight.*

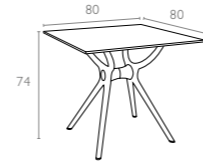
80x80 cm



White



Black



335 AIR LEGS SMALL

Air Legs are made up of polypropylene reinforced with glass fiber with the latest generation of air moulding thermoplastic injection. For indoor and outdoor use. Can be disassembled.

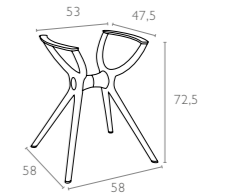


White



Black

** Top min. 70x70 cm, Top max. 90x90 cm*



705 AIR TABLE 140

Table with plastic legs with HPL compact laminated tops 12 mm available in white and black. For indoor and outdoor use. Can be disassembled.

** Dark colors not recommended in direct sunlight.*

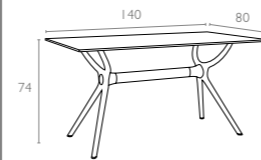
80x140 cm



White

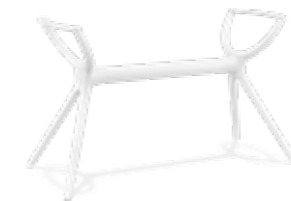


Black



336 AIR LEGS MEDIUM

Air Legs are made up of polypropylene reinforced with glass fiber with the latest generation of air moulding thermoplastic injection. For indoor and outdoor use. Can be disassembled.

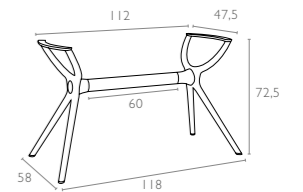


White



Black

** Top min. 70x120 cm, Top max. 80x160 cm*



715 AIR TABLE 180

Table with plastic legs with HPL compact laminated tops 12 mm available in white and black. For indoor and outdoor use. Can be disassembled.

** Dark colors not recommended in direct sunlight.*

90x180 cm



White

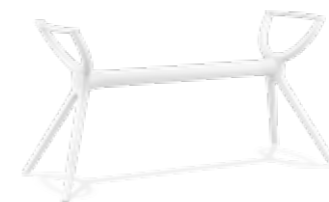


Black



337 AIR LEGS XL

Air Legs are made up of polypropylene reinforced with glass fiber with the latest generation of air moulding thermoplastic injection. For indoor and outdoor use. Can be disassembled.

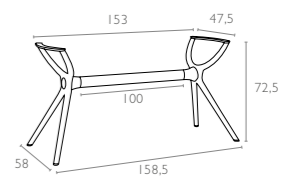


White



Black

** Top min 90x180 cm, Top max 100x200 cm*



118 SKY FOLDING LEGS

Sky folding leg is made of durable weather-resistant resin. Metallic frame will never unravel, rust or decay. It is UV protected which insures the colors will not fade. Can be disassembled and suitable for werzalit or HPL compact tops. For indoor and outdoor use.



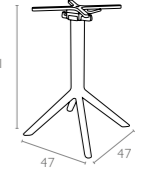
White



Black



* Top min: 50x50 cm Top max: 70x70 cm



107 SKY LEGS

Sky leg is made of durable weather-resistant resin. Metallic frame will never unravel, rust or decay. It is UV protected which insures the colors will not fade. Can be disassembled and suitable for werzalit or HPL compact tops. For indoor and outdoor use.



White



Taupe

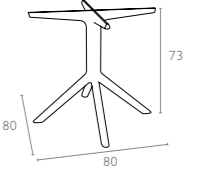


Dark Grey



Black

* Top min: 70x70 cm Top max: 90x90 cm



160 OCTOPUS 60

Octopus Table is made of durable weather-resistant resin. Metallic frame will never unravel, rust or decay. It is UV protected which insures the colors will not fade. Can be disassembled. For indoor and outdoor use.



White



Taupe



Silver Grey



Dark Grey



Black



Yellow

Ø 60 cm



161 OCTOPUS BAR

Octopus Bar Table is made of durable weather-resistant resin. Metallic frame will never unravel, rust or decay. It is UV protected which insures the colors will not fade. Can be disassembled. For indoor and outdoor use.



White



Taupe



Dark Grey



Black



Ø 60 cm

116 SKY FOLDING BAR TABLE 60

Sky folding bar table is made of durable weather-resistant resin. Metallic frame will never unravel, rust or decay. It is UV protected which insures the colors will not fade. Can be disassembled. For indoor and outdoor use.
60x60 cm



White



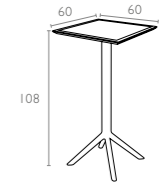
Taupe



Dark Grey



Black



164 ARES 80

Ares 80 Table is made of durable weather-resistant resin. Non-metallic frame will never unravel, rust or decay. It is UV protected which insures the colors will not fade. Can be disassembled. For indoor and outdoor use.
80x80 cm



White



Taupe



Teak



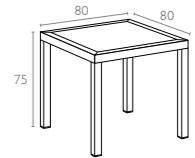
Brown



Dark Grey



Black



186 ARES 140

Ares 140 Table is made of durable weather-resistant resin. Non-metallic frame will never unravel, rust or decay. It is UV protected which insures the colors will not fade. Can be disassembled. For indoor and outdoor use.
80x140 cm



White



Taupe



Teak



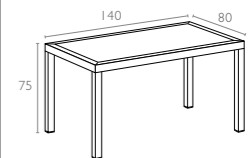
Brown



Dark Grey



Black



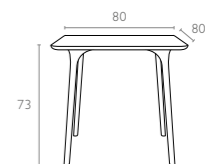
685 MAYA 80

HPL compact laminated tops 12 mm with the latest generation of air moulding thermoplastic legs. For indoor and outdoor use. Can be disassembled.

80x80 cm



White



675 MAYA 120

HPL compact laminated tops
12 mm with the latest generation
of air moulding thermoplastic legs.
For indoor and outdoor use.
Can be disassembled.

Ø 120 cm



White



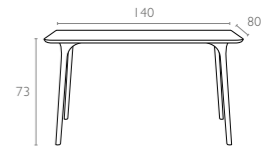
690 MAYA 140

HPL compact laminated tops
12 mm with the latest generation
of air moulding thermoplastic legs.
For indoor and outdoor use.
Can be disassembled.

80x140 cm



White



500 - 510 - 520 ICE

Table with clear transparent
polycarbonate leg and painted
aluminium base. Werzalit tops,
resistant to outdoor use, available
in white, black and silver grey.
For indoor and outdoor use.

Code 500 Ø 60 cm
Code 510 Ø 70 cm
Code 520 Ø 80 cm



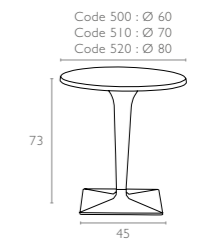
White



Black



Silver Grey



550 - 560 ICE

Table with clear transparent
polycarbonate leg and painted
aluminium base. Werzalit tops,
resistant to outdoor use, available
in white, black and silver grey.
For indoor and outdoor use.

Code 550 60x60 cm
Code 560 70x70 cm



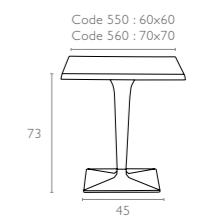
White



Black



Silver Grey



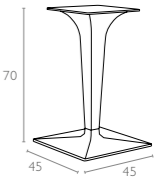
310 ICE Leg & Base

Clear transparent polycarbonate leg and painted aluminium base. For indoor and outdoor use.



Clear
Transparent

Made with
Makrolon®
The high-tech polycarbonate



800 MANGO

Stacking table with the latest generation of air moulding thermoplastic injection. For indoor and outdoor use.

72x72 cm



White



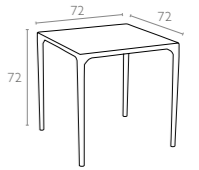
Beige



Orange



Silver Grey



758 MANGO ALU

Stacking table with the latest generation of air moulding thermoplastic injection with legs in anodized aluminium. For indoor and outdoor use.

72x72 cm



White



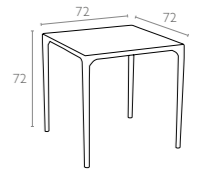
Beige



Orange



Silver Grey



770 FORZA

Folding table with legs in anodized aluminium. Diameter 30 mm. Table top in recyclable polypropylene. For indoor and outdoor use.

80x80 cm



White



Beige



Orange



Red



Light Green



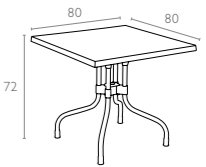
Black



Silver Grey



Teak



750 SORTIE

Table top in recyclable polypropylene, anodized aluminium legs. Diameter 25 mm. For indoor and outdoor use. Can be disassembled.

70x70 cm



White



Beige



Orange



Red



Light Green



Black

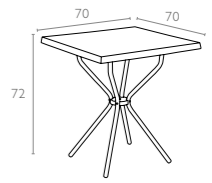
**720 POPPY 80**

Table top in recyclable polypropylene, anodized aluminium legs. Diameter 25 mm. For indoor and outdoor use. Can be disassembled.

Ø 80 cm



White



Beige



Orange



Red



Light Green



Black

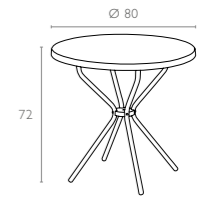
**710 ELFO 70**

Table top in recyclable polypropylene, anodized aluminium legs. Diameter 25 mm. For indoor and outdoor use. Can be disassembled.

Ø 70 cm



White



Beige



Orange



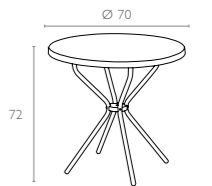
Red



Light Green



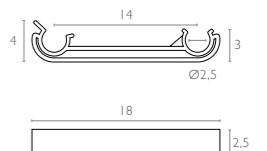
Black

**097 LINK**

Link linking device in polypropylene to be fixed on the frame. Suitable for all round legs Ø 25mm.



Silver Grey



415 DODO

Suspension lamp in polycarbonate with 25W energy saving lamp. The diffuser can be removed without dismantling the electrical body, for an easy fitting and removal.



Made with **Makrolon®**
The high-tech polycarbonate



Clear
Transparent



Black
Transparent



Violet
Transparent



Amber
Transparent



Pink
Transparent



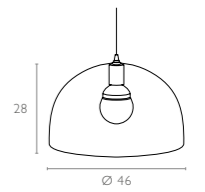
Blue
Transparent



Red
Transparent



Glossy
White



410 NOVA

Suspension lamp in polycarbonate with 25W energy saving lamp. The diffuser can be removed without dismantling the electrical body, for an easy fitting and removal.



Made with **Makrolon®**
The high-tech polycarbonate



Clear
Transparent



Black
Transparent



Violet
Transparent



Amber
Transparent



Pink
Transparent



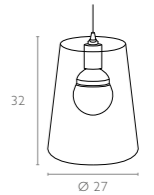
Blue
Transparent



Red
Transparent



Glossy
White



420 SMART

Table lamp made of transparent or coloured injected polycarbonate, with 40W lamp. Perfect gift idea.



Made with **Makrolon®**
The high-tech polycarbonate



Clear
Transparent



Black
Transparent



Violet
Transparent



Amber
Transparent



Pink
Transparent



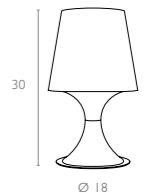
Blue
Transparent



Red
Transparent



Glossy
White

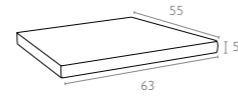


899 ARTEMIS XL SEAT CUSHION

5 cm thick seat cushion covered with polyester fabric and finished with piping. Cushion is specially designed for Artemis XL armchair.



White Light Grey Beige

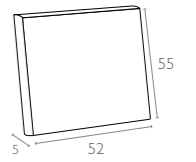


900 ARTEMIS XL BACKREST CUSHION

5 cm thick backrest cushion covered with polyester fabric and finished with piping. Cushion is specially designed for Artemis XL armchair.



White Light Grey Beige

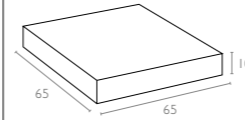


141 MYKONOS SEAT CUSHION

10 cm thick cushion covered with Etisilk polyester fabric and finished with piping. Cushions are specially designed for Mykonos Lounge Set. Water resistant with UV.



Beige Light Brown Dark Grey Black

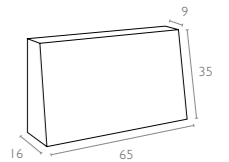


142 MYKONOS BACKREST CUSHION

10 cm thick cushion covered with Etisilk polyester fabric and finished with piping. Cushions are specially designed for Mykonos Lounge Set. Water resistant with UV.



Beige Light Brown Dark Grey Black

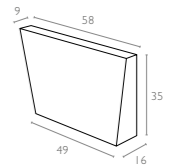


143 MYKONOS CORNER CUSHION

10 cm thick cushion covered with Etisilk polyester fabric and finished with piping. Cushions are specially designed for Mykonos Lounge Set. Water resistant with UV.



Beige Light Brown Dark Grey Black



INFORMATION

Technical dates and pictures in this catalogue are indicative and may not be considered binding; Siesta reserves the right to modify without notice for technical or commercial reasons the products in this catalogue. It is forbidden to re-produce the project or to re-print the catalogue.

All dimensions are in **cm**.

SYMBOLS KEY
Ø = Diameter
H = Height

Siesta App available on the App store



Art Direction & Graphic Art
www.adkreatik.com



is

